

August
1934

SHORT WAVE RADIO



Edited by

Robert Hertzberg and Louis Martin

IN THIS ISSUE:

**Common and Uncommon Uses
of Regeneration**
By *Robert S. Kruse*

Foreign Station Data
By *J. B. L. Hinds*

**The Truth About Treasure
Finders**

**A Special Low-Noise Level
Superheterodyne**
By *J. A. Worcester*

**A Transportable Receiver
for the Car**

**A Modern Short-Wave
Converter That Works**

**Best Station Lists in
Print**

and now
4-Inch Radio Waves!

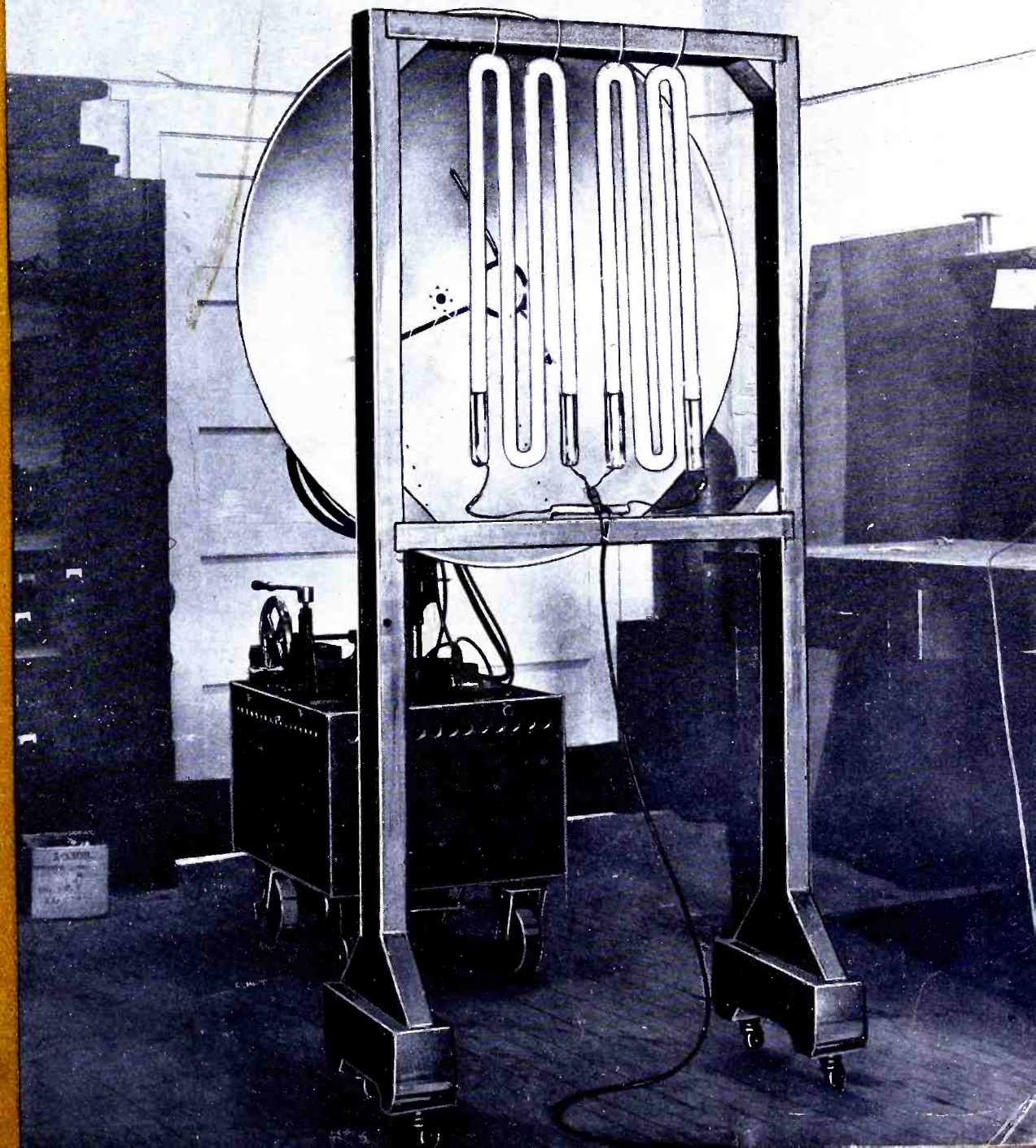

25¢
IN CANADA
30¢

BOOKS FOR THE RADIO MAN

Many of the questions asked daily by radio experimenters, constructors and listeners all over the country are answered completely and clearly in various books. To assist radio men in buying books best suited for their own particular needs, we have made a selection of representative works that we can recommend very highly. These books are all up-to-date and will prove very valuable.

"The Radio Amateur's Handbook"

238 Pages of Data

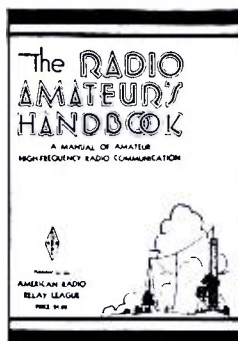

Price \$1.00 postpaid

The RADIO AMATEUR'S HANDBOOK was first published in the fall of 1926. It was in response to a growing demand upon the American Radio Relay League for some sort of a manual of operation for short-wave experimental radio work. The first edition met with great favor and two reprintings were necessary to supply the demand. Since that time ten subsequent editions have been published and more than 215,000 copies have been sold.

The latest edition (11th edition, published January, 1934) is approximately 15% larger than the first edition, and represents probably the most compre-

hensive revision yet attempted. New receiver circuits and designs are presented, together with a thorough treatment of the recently-developed "single-signal" sets. A completely re-written 36-page chapter is devoted to all that is new in the world of transmitters. New circuits and layouts are given, all problems which face the transmitting amateur being discussed in a lucid and comprehensive manner. The radio telephony chapter represents all new material. New designs for Class B modulators and speech amplifiers are featured. Still another new chapter is that on antennas.

"How to Become a Radio Amateur"

Completely done over in 1934 style, telling all about amateur radio and describing the latest equipment—*push-pull transmitter—bandspread pentode receiver—simplest of monitors.*

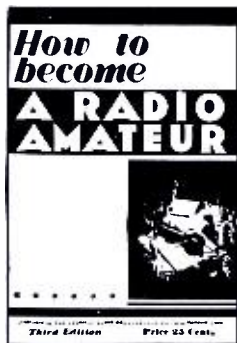

The third edition of "How to Become a Radio Amateur" marks another milestone in amateur development. Still the standard elementary guide for the would-be amateur, the simple, inexpensive station described incorporates features which in the past have been confined to the more advanced layouts. The designs have been made flexible, so that parts out of the junk box can be readily substituted. The performance of the completed station is such that any amateur can own and operate it with satisfaction and pleasure. It's a real amateur station, with construction and operation described in clear, understandable language.

Price \$.25. Postpaid

"Radio Amateur's License Manual"

Before you can operate an amateur transmitter, you must have a government license and an officially assigned call. These cost nothing—but you must be able to pass the examination. The License Manual tells how to do that—tells what you must do and how to do it. It makes a simple and comparatively easy task of what otherwise might seem difficult. In addition to a large amount of general information, it contains 198 typical questions and answers such as are asked in the government examinations. If you know the answers to the questions in this book, you can pass the examination without trouble.

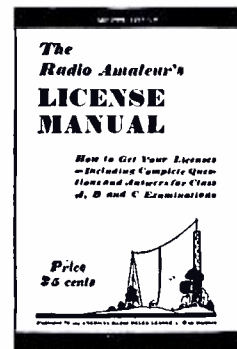

Price \$.25. Postpaid

The safest way to remit money is by post office or express money order. Hold your receipt until your books arrive. Do not send coins through the mail. Write or print your name and address clearly. Prompt deliveries of all orders guaranteed. No books sent on approval or C. O. D.

Standard Publications, Inc., 1123 Broadway, New York, N. Y.



J. E. SMITH, Pres. National Radio Institute

I WILL TRAIN YOU AT HOME IN SPARE TIME FOR A GOOD RADIO JOB!



Good Position Station WSMK



JOHN HAMDUK, Jr., 3 Broxey Apts., Southern Hills, Dayton, Ohio.

"I have a good job, make a nice salary, and all my success is due to N.R.I. I am operator of Station WSMK. I highly recommend the N.R.I. Course. It enabled me to pass the Government examination for an operator's license."

\$18 a Week in Spare Time

"Although I am doing only spare time Radio work, I have averaged \$18 a week. I recommend N.R.I. training. It is certainly a complete Course. In a short time it will take a man, give him a sound fundamental training in Radio theory, practice, and design." STEPHEN J. DRAPCHIATY, 407 Wunderlich Ave., Barberton, Ohio.



Nets about \$50 a Week besides Sales

"I have been getting along fine. I average ten calls a week, which nets me about \$50, not counting profits on sales. I have serviced almost every make of set and have earned more than I ever expected. I owe my success to the N.R.I. and its wonderful Course." BERNARD COSTA, 150 Franklin St., Brooklyn, New York.

FREE:

Radio Servicing Tips

Let me PROVE that my Course is clear, easy to understand and fascinating to study. Send the coupon for a free lesson, "Trouble Shooting in D.C., A.C., and Battery Sets." This interesting lesson gives 132 ways to correct common Radio troubles. I am willing to send this book to prove that you too can master Radio—just as thousands of other fellows have done. Many of them, without even a grammar school education, and no Radio or technical experience, have become Radio experts and now earn two or three times their former pay. Mail the coupon now.



FREE BOOK TELLS HOW MAIL COUPON

Act today for better pay. Act today to break away from a low pay, no-future job. Act to get away from having to skimp, scrape to pay your bills. Mail coupon for my free 64-page book. It tells you how I will train you at home in your spare time to be a Radio Expert; about my training that has doubled and tripled the pay of many.

Many Radio Experts make \$40 \$60, \$75 a Week

Consider these facts—think of the good jobs they stand for. Over 16,000,000 Radio sets in use, over 600 broadcasting stations, over 40 large manufacturers of Radio sets, over 3,000 manufacturers of parts, over 100 Police Departments Radio equipped, airplanes and airports Radio equipped. Thousands of ships touching every seaport of the world. Radio equipped. Over 35,000 stores selling sets and parts, about 2,000,000 autos Radio equipped and about 20,000,000 unequipped. Loud speaker systems wherever people gather, indoors and outdoors. Commercial Radio stations dotting our coast lines. Radio a big industry—is growing bigger fast. A few hundred \$40, \$60, \$75 a week jobs, have grown to thousands.

Get ready now for Jobs like these

A spare time or full time service shop; installing, maintaining, operating—broadcast, aviation, commercial, ship, television and police stations. A Radio retail business of your own. Installing, maintaining, servicing, loud speaker systems. A service or sales job with a store or jobber. I'll train you for good jobs in every branch of Radio.

Many make \$5, \$10, \$15 a week extra in Spare Time almost at once

Every neighborhood can use a good part time serviceman. I'll start giving you special instruction material, plans, ideas, the day you enroll, for making money in spare time. Get my book—read how many of my students make \$200 to \$1,000 in their spare time while learning.

Your money back if not satisfied

I'll make this agreement with you. If you are not entirely satisfied with my lesson and instruction service when you finish, I'll refund your tuition.

Find out what Radio Offers

Mail the coupon. My book of information on Radio's spare time and full time opportunities is free to any ambitious fellow over 15. Read what Radio offers you. Read about the training I offer you. Read letters from graduates—what they are doing and making. There's no obligation. Mail coupon in an envelope or paste it on a postal card—NOW.

J. E. SMITH, President
National Radio Institute, Dept. 4 H-58
Washington, D. C.

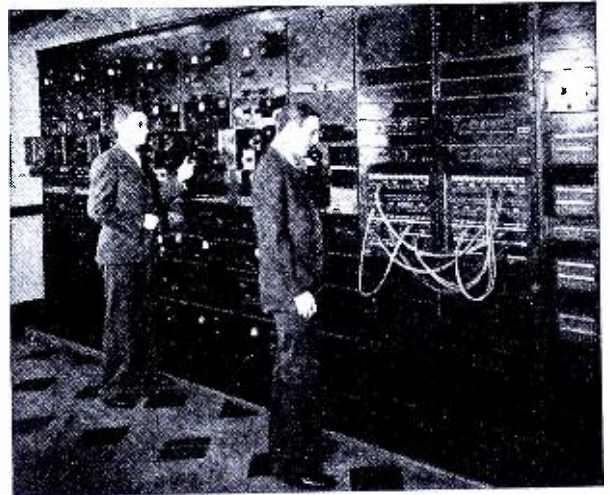

SAVE MONEY--LEARN AT HOME

Special Equipment Gives You Practical Experience

Hold your job. No need to leave home and spend a lot of money to be a Radio Expert. I'll train you quickly and inexpensively right at home in your spare time. You don't need a high school or college education. Many of my successful graduates didn't finish grade school. My practical 50-50 method of training—half with lessons, half with Radio equipment—gives you broad practical experience—makes learning at home easy, fascinating, practical and rapid. There is opportunity for you in Radio. Old jobs are becoming more complicated—many need better trained men. New developments are making new jobs. Short waves, loud speaker systems, police Radio, auto Radio, aviation Radio, television—Radio's newest uses are covered by my training. Here's a field that's growing. It is where you find growth that you find opportunity.

I have doubled and tripled the salaries of many



MAIL THIS NOW!

J. E. SMITH, President
National Radio Institute, Department 4 H-58
Washington, D. C.

Dear Mr. Smith: I want to take advantage of your Special Offer. Send me your two books, "Trouble Shooting in D.C., A.C., and Battery Sets" and "Rich Rewards in Radio." I understand this does not obligate me. (Please print plainly.)

NAME.....AGE.....

ADDRESS.....

CITY.....

STATE..... "M"

The Tested Way to BETTER PAY

SHORT WAVE RADIO

devoted to short-wave transmission and reception in all their phases

Robert Hertzberg, *Editor*

Louis Martin, B. S., *Technical Director*

IN THIS ISSUE

Of General Interest:

And Now 4-inch Radio Waves.....	4
Regular Broadcasting on 7 Meters through Buffalo Station....by Hamilton Woodle	7
The Truth about Radio Treasure Finders by Louis Martin	8
Byrd "Mailbag" Delivered Regularly.....	9
Foreign Station Department Conducted by J. B. L. Hinds	10
New World List of Stations.....	13
Best Short-Wave Stations.....	16
List of International Call Assignments.....	17
Arctic-to-Antarctic S.W. Link to be Attempted	17
Reception Reports from Readers.....	18
Latest Data on American and Foreign S.W. Broadcasters	19
Dansville, N. Y., Listener has Exceptional Foreign Log	27

Of Explanatory Nature:

Regeneration in the Tuned R.F. Stage.....	6
Terrestrial Magnetism and Short-Wave Radio Reaction in Radio Receivers by Joseph L. Hurff	20
Common and Uncommon Uses of Regenera- tion	24

For the Constructor:

A Transportable Set for the Car.....	28
Some Real Information on Short-Wave Con- verters	31
A Low-Noise Level Superheterodyne By J. A. Worcester, Jr.	33
How to Build a Sensitive 4-Tube S.W. Re- ceiver	36

IN FUTURE ISSUES:

THIS COMING FALL promises to be a good one as far as short-wave listeners and experimenters are concerned. Many new receivers with novel and helpful additions are being brought out by manufacturers. It is our purpose to continue in the Fall, as we have in the past, to give unbiased descriptions of those receivers which we think suitable for our readers.

THE ANTENNA PROBLEM is still a pertinent one. Although SHORT WAVE RADIO has run considerable material on this subject, and in spite of the fact that we have answered a number of puzzling questions in a very direct manner in our July issue, a large proportion of our mail still contains queries on the antenna situation. The many types of antenna systems now available are a material aid to the listener, although, unfortunately, it is difficult for him to determine just which system is the best for his purpose. Here, again, SHORT WAVE RADIO expects to come to the rescue with a symposium on most of the widely used antenna systems available.

THE DISCUSSION ON THE USE OF REGENERATION in the tuned r.f. stage contained in this issue is a preliminary step toward the verification of its merits. We are going ahead with the construction of a simple receiver using the principles set forth and expect to have it ready for your inspection in a very early issue.

The entire contents of SHORT WAVE RADIO are copyrighted by Standard Publications, Inc., and must not be reproduced without permission of the copyright owners.

SHORT WAVE RADIO—Monthly. Entered as second-class matter September 15, 1933, at the post office at Chicago, Illinois, under the Act of March 3, 1879.

SHORT WAVE RADIO is published on the first of every month preceding date of issue. Subscription price is \$2.50 a year in the United States and possessions; Canada and foreign countries \$3.00 a year. Individual copies, \$.25 in the United States and possessions; Canada and foreign countries, \$.30. Published by Standard Publications, Inc., 4600 Diversey Avenue, Chicago, Illinois. Editorial and advertising offices, 1123 Broadway, New York, N. Y. Louis Martin, President; Robert Hertzberg, Secretary-Treasurer;

SHORT WAVE RADIO is distributed by Pictorial Distributing Corp., 222 West 39th Street, New York, N. Y.

Articles on short-wave subjects are desired, and are paid for on publication. The editors will be glad to discuss contributions with authors. Unused or unsolicited manuscripts will not be returned unless full postage is furnished by the contributor.

Address all correspondence of editorial or advertising nature to SHORT WAVE RADIO, 1123 Broadway, New York, N. Y. Telephone: CHelsea 2-6620 and 6621.

★★ This summer let **GHIRARDI** help you build a new short-wave set

Don't just sit back and wait for better reception in the Fall. Start preparing now. Improve your set. Build a new one. And here's the first thing to do about it! Get a copy of Ghirardi's **RADIO PHYSICS COURSE**. In this book of almost 1,000 pages you will find just the dope you need to guide you in building



an up-to-date short-wave set. It's packed full of useful diagrams and illustrations (508 in all) you will want to study and put into application. Above all, Ghirardi's book is practical. It contains just the sort of material short-wave fans say they have never been able to find before.

Summer is the time to read up on radio

Whether you build a new set or not, make it a point to read Ghirardi this summer. Take this opportunity to fill out your background by means of this comprehensive authoritative survey. Radio is a science that has to be studied in whole, rather than in parts. You may get the clue to some problem you're working on right now from a principle that seems entirely unrelated. Go over the whole field and then you'll be sure to have everything.

Ghirardi's book is acknowledged by authorities to be the standard book in the field. It covers not only radio, but electrical theory,

television, the talkies, and many other affiliated subjects. Ghirardi presents his material so clearly and simply that it is easy for anyone to understand.

Many experimenters write to tell us this is the one book they are never without. It is text-book, hand-book and reference book—all in one—and, best of all, it's available to you at a price much lower than you would expect to pay for such a work—only \$3.85, plus 15c for handling charges. Our present printing may be exhausted before the summer is over—so send in the coupon right away.

RADIO & TECHNICAL PUBLISHING CO.

Partial List of Short-Wave Topics in GHIRARDI'S "Radio Physics Course"

Amateur transmission; Types of short-wave receivers; Short-wave tuner system; Plug-in coils and waveband-switching systems; Short-wave tuner design; Band-spreading coils; Simple regenerative receiver; "Fringe howl"; "Dead spots" in tuning; Short-wave superheterodyne; Short-wave converters; Short-wave adapters; Operating the short-wave receiver; Skipping and fading of short-wave radiations; Micro, or quasi-optical rays.

Mail the Coupon Today

TO: Radio & Technical Publishing Co.
45 Astor Place, Dept. S-8, New York City

- Send me 1 copy of Ghirardi's **RADIO PHYSICS COURSE**, 2nd revised edition. (Enclosed find \$4.00.) (Send C.O.D.)
- Send me 1 copy of Ghirardi and Freed's **RADIO SERVICING**—121 illustrations, 182 pages. (Enclosed find \$1.75.) (Send C.O.D.)
- Please send me free circular describing these books.

Name.....

Address.....

City.....State.....

Occupation.....

and now
4-Inch Radio Waves!

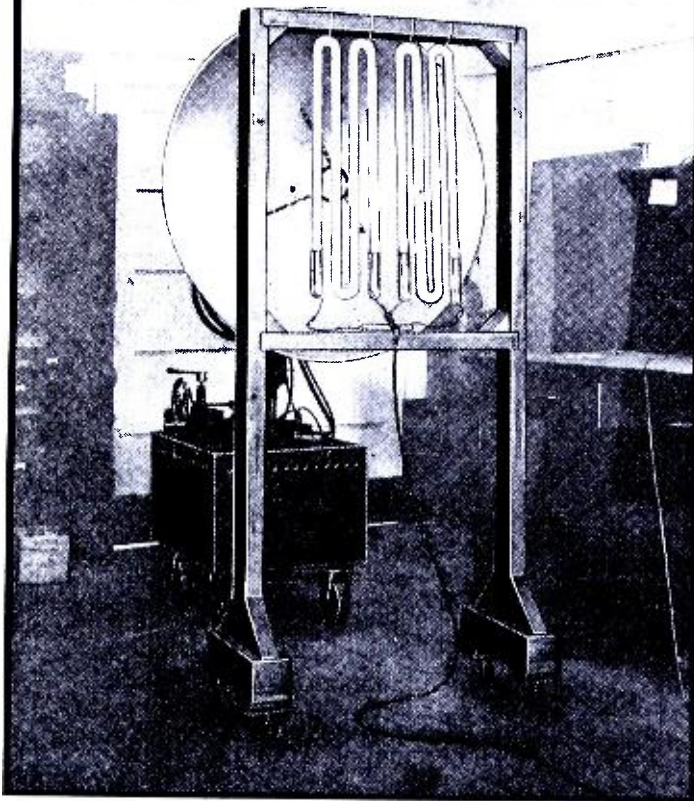

Photograph of the transmitter and modulator set up for action. The wave from the transmitter is absorbed by the gas by an amount depending upon the ionization.

AT the Ninth Annual Convention of the Institute of Radio Engineers, held in Philadelphia on May 28th, 29th and 30th, a number of interesting papers depicting the present trend in short-wave equipment were read. Among these was an interesting description of a new method of generating and modulating 9 cm waves, which was given by I. Wolff, E. G. Linder and R. A. Braden of the RCA Victor Co. The system of generation involved made use of a special magnetron tube and a crystal detector, the details of which will be given in the following description.

As is well known, wavelengths as low as 17 cm have been used successfully for communication across the English Channel and continuous waves of as low as 1 cm have been produced in the laboratory by Professor Williams at the University of Michigan, these 1 cm waves, however, having a very small power output. While it has been the aim of the authors to study the production of electromagnetic waves of a length less than 10 cm, the apparatus which is used to produce the shorter waves is essentially the same as that used in the neighborhood of 10 cm. With the exception of a reduction in size, the results which are described here are also applicable to production of the shorter waves, down to perhaps 1 cm.

The magnetron consists essentially of a regular diode having a filament

or heater and a cylindrical anode. An electromagnet connected to a source of d.c. is so placed that its field is parallel to the axis of the filament, as shown in Fig. 1A. With no current through this field winding, an electron leaving the filament is accelerated directly toward the plate, which has a positive potential similar to that of any other plate. However, when the field is excited, the lines of force travel down through the tube parallel to the filament. The effect of this constant magnetic field is to make the electron move at right angles to its normal path, which is radially from the filament to plate.

Hence, an electron has two forces acting on it, an electrostatic force due to the positive plate potential and a magnetic attraction due to the magnetic field. The effect of the former is to accelerate the electron toward the plate; the effect of the latter is to make the electron move at right angles to its normal direction. Which of the two paths the electron assumes is dependent entirely upon the value of the plate voltage and the strength of the magnetic field. In the usual course of adjustment, conditions are so fixed that the electron executes an arc similar to that shown in Fig. 1B.

In order to obtain good results on the ultra high frequencies, it has been found essential to split the anode into two halves such as shown in the schematics.

The split anode magnetron tube

has been used as the basis for this development. A number of essential improvements have been made which have added greatly to its stability and power handling capacity.

This tube has been called an "end-plate magnetron." It is capable of developing outputs of $2\frac{1}{2}$ watts at 9 cm. The efficiency, comparing 9 cm generated energy to the sum of the anode and end-plate dissipation, is approximately 12%. In explaining the action of this tube, it will be best first to review briefly the theory of the simple split anode magnetron when used as an electronic oscillator. Refer again to Fig. 1A. In order to generate oscillations, the anode potential and magnetic field must be adjusted so that electrons which leave the filament are deflected by the magnetic field so that they barely graze the anode, as shown in Fig. 1B. With this adjustment, it has been found that the tube has a negative resistance characteristic, which encourages the generation of oscillations at the natural frequency of any circuit which is attached to it. As the frequency is made higher so that the time of transit of the electron between filament and anode becomes appreciable, an additional condition for oscillation must be fulfilled; the time taken by an electron for complete transit in the tube must be equal to the period of the radiated wave.

When an ordinary split anode magnetron is used in a uniform magnetic field, very little output results when the tube is exactly parallel to the field. Maximum output results when the tube is tilted so that the filament is approximately at 5 or 10 degrees to the magnetic field. This has been explained as necessary so that the electrons which are emitted from the filament and which are caused to rotate in the space between the filament and the plate can spiral out from one end of the plate without causing injurious space charge

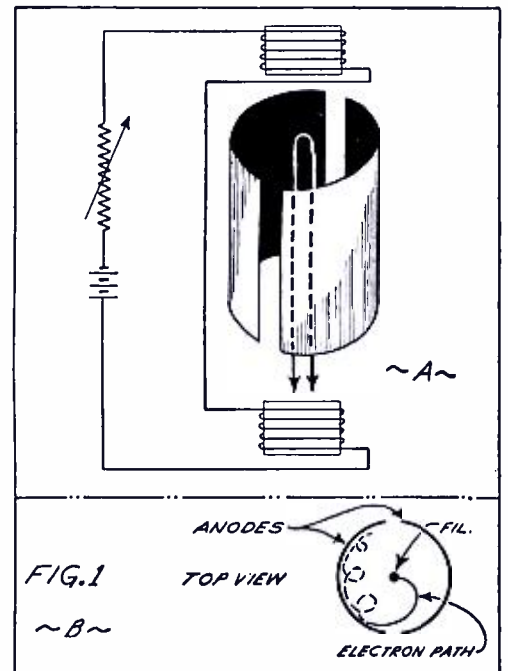

An elementary diagram of the magnetron. The magnetic field is parallel to the axis of the filament, as shown.

effects. If this theory is valid, it is evident that similar results can be obtained with possibly better control by applying an electrostatic field along the axis of the filament with the field in such a direction as to draw the electrons out from the end. Experiments by the authors have shown that this deduction is justified and that when an electrostatic field is applied as indicated, the tube must then be aligned so as to have the filament parallel to the magnetic field. A tube constructed to attain this result is shown in Fig. 2.

Oscillator Circuit

It will be noticed that a bar is placed across the transmission line and close to the anodes of the tube. This bar performs several functions. It prevents the formation of long-wave parasitic oscillations, to which the remainder of the antenna and transmission line would be tuned, by placing a "short" for these oscillations between the anodes and the transmission line. At the same time, it stabilizes the production of the 9 cm waves by providing a small looped circuit consisting of the two anodes and the bar, which is tuned to this wavelength.

The transmission and radiation systems are shown in the photographs, and merely consist of a dipole antenna in the focus of a parabolic reflector. The length of the transmission line must be adjusted to correspond to the wavelength being generated, the distance from the shorting bar (which is adjacent to the anodes) to the antenna being a multiple of a half wavelength.

The tube output can be modulated on either the end plate or the anode. This is accomplished by placing the secondary of a transformer in series with the supply voltage, since the tube has a characteristic in which the output varies considerably as the ratio between end plate and anode plate voltage is changed. Another type of modulation, which may have wide applications, has been developed so as to be able to control the amount of frequency modulation. As is well known, a certain amount of frequency modulation accompanies the variation in output which is accomplished by varying the plate circuit voltage on an electronic oscillator, although this is nowhere near as serious for the magnetron oscillator as it is for the Barkhausen type, since the constant magnetic field supplies a stabilizing influence. (See the April, 1934, issue for information on the Barkhausen type of oscillator.) Nevertheless, as more refined receivers are developed, this frequency modulation may cause difficulties.

In order to eliminate this effect, a system has been developed in which an unmodulated wave is radiated, allowing the transmitter to operate under constant voltage supply conditions, and the modulation is accomplished by intercepting

the unmodulated beam by a medium which changes its absorption, reflection, and index of refraction for electromagnetic waves. The Heaviside layer constitutes such a medium, and owes its properties to the presence of ions (for practical purposes probably electrons) of different densities in the atmosphere. By increasing the ion density sufficiently, the effects which are produced by the Heaviside layer can be brought into the room. The modulating device consists merely of a gas discharge tube which is placed in the path of the wave. As the current through this discharge tube is changed, the ion density varies, resulting in variable index of refraction and absorption for the electromagnetic waves. Sufficient voltage to maintain a discharge continuously is supplied from a rectifier unit. (See Fig. 3.) In series with this d.c. supply is the secondary of a transformer whose primary is attached to a modulating source. It can be shown experimentally that modulation can be obtained by passing the wave *through* this gas, in which case the modulation is obtained by absorption, or by using the tube as a reflector, in which case the modulation is largely by variation in refraction.

Effect of Voltages

The maintenance of electronic oscillations depends considerably more on the constancy of the supply voltages than oscillations which are dependent entirely on circuit constants. For this reason, the apparatus used in this experiment is provided with special regulators for maintaining these voltages constant. The magnet unit has a constant current regulator which compensates both for variations in the resistance of the field magnet, due to heating of its coils, and for variations in the supply voltage. The anode and end plate supply is a constant voltage device which compensates for changes in the supply voltage. The filament supply can either be a constant current or a constant voltage regulator.

A number of measurements of attenuation of the 9 cm waves were made in which the distance between the receiver and the source was

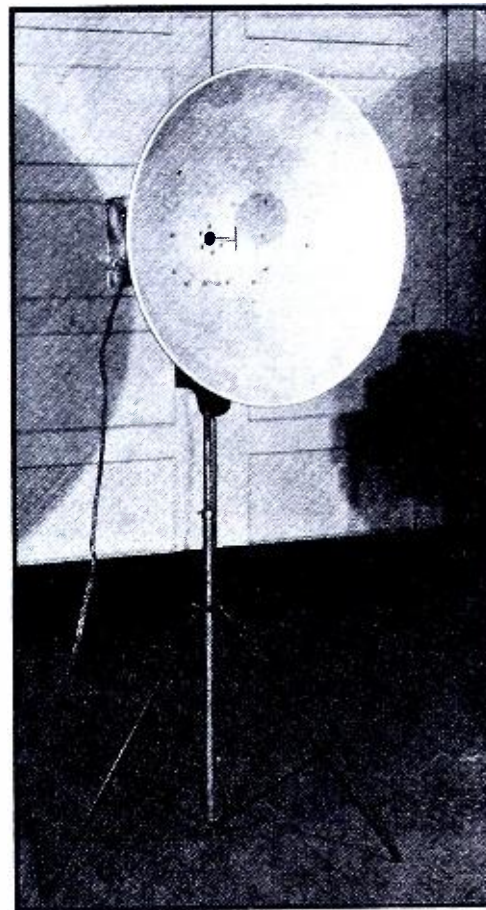

Photograph of the receiver. Note the dipole antenna at the focal point.

varied, while the intensity of the received signal was measured. These experiments were all made with the receiver and transmitter at a sufficient height above the ground so that intervening objects were not interposed. It was found that an inverse distance law for field strength was followed, indicating that attenuation was not serious.

Certain types of crystal detectors are quite sensitive for the reception of centimeter waves. Iron pyrites has been found to be the most efficient of those tried. As is well known, these crystals are, however, notably unstable as regards their detecting efficiency, it being necessary to find a sensitive point and maintain a contact at this sensitive point in order to get satisfactory operation. The authors have found that it is considerably more difficult to find sensitive points for the short wavelengths than it is for the higher waves and that the sensitivity at one of these sensitive points is more

Schematic circuit of the tube used for the production of the 9 cm waves. The capacity between the plates and the wiring around the bar constitute the oscillating circuit.

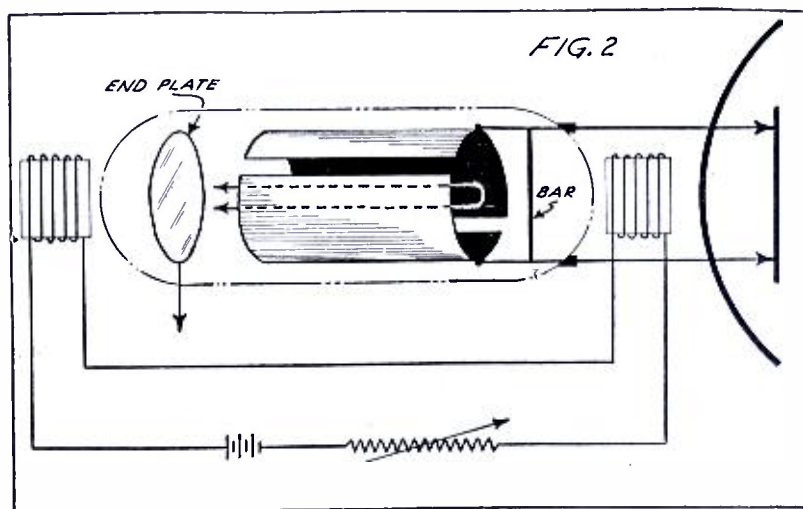

likely to vary for the shorter wavelengths. It also requires a considerably smaller pressure on the contact point, probably because a very small area of contact must be used in order to keep the shunt capacity at a low enough value. For these reasons, some experimental work has been done with tube detectors to take the place of crystals. The so-called positive grid detectors have been used successfully by Marconi at longer wavelengths. In order to make use of the same detectors for waves below 10 cm, much more care in the design of the tube is required.

With the plate potential given optimum adjustment, the tube will act as a detector over a wide range of grid voltages even when it is impossible to apply sufficient potential to obtain electron resonance for 3000 megacycles.

The magnetron tube can also be used as a detector. A special split-anode magnetron was built with elements of reduced size and in a small diameter glass envelope so that the magnetomotive force needed for the required field could be held as low as possible. The r.f. was supplied symmetrically to the two anodes; the a.f. was obtained by placing the primary of a transformer in the leads which supply the two anodes in parallel. Detecting action is obtained for any magnetic field strength if the plate potential is adjusted so that electrons barely graze the cylindrical anodes. The most sensitive detection takes place where the plate-current, plate-potential characteristic is curved, i.e. either at the bottom or top, the latter being superior. Although detection takes place for all electron rotation speeds, providing the right relation between applied potential and magnetic field exists, a much greater increase in sensitivity is obtained if the field is adjusted so that the electron rotation period is equal to that of the

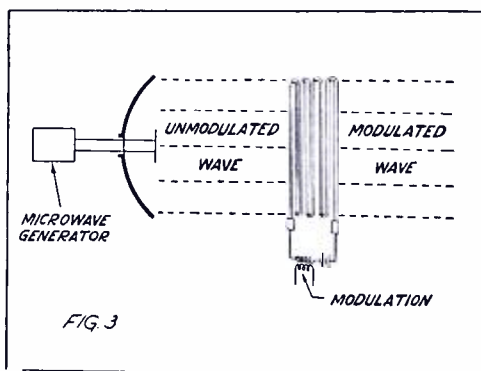

Sketch showing how the wave from the transmitter may be modulated by varying the density of the gas in the tube. Modulation may also be effected by varying the end-plate or anode voltage by means of a transformer and modulating source.

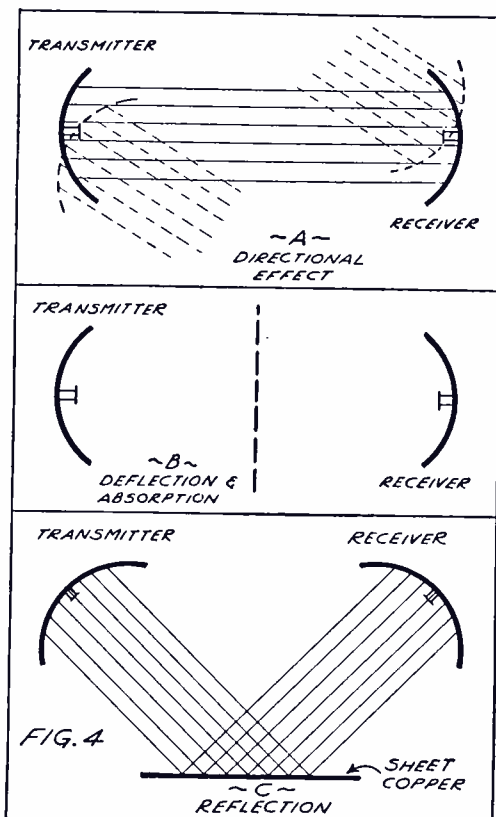

Sketches of some of the experiments made by the authors during the demonstration of the transmitter and receiver. See the text for details.

impressed signal. When the tube is adjusted for this condition, it is the most powerful detector the authors have experimented with.

Some very convincing demonstrations were given at the end of the paper. The transmitter was set up at one side of the room and the receiver at the other. The two parabolic reflectors were focused on one another, and the apparatus placed in operation. The transmitter was modulated in the plate supply and the system worked perfectly. Then the receiver reflector was rotated slightly so that it did not face the transmitter directly. The response decreased considerably, showing that 9 cm waves, at least, are extremely directional. The same effects, of course, were obtained when the transmitter reflector was rotated. To show the effect of reflection, an ordinary piece of copper screening was placed between the transmitter and the receiver. The response again decreased considerably, showing that direct reflection and absorption of such short wavelengths produces considerable attenuation. These tests are illustrated in Figs. 4A and 4B. The phenomenon of reflection was vividly illustrated by setting up the apparatus as per the sketch 4C. A sheet of copper was placed at some distance from the receiver and transmitter as shown. At some point where the angle of incidence equalled the angle of reflection, the copper screen reflected the wave from the transmitter to the receiver with very little decrease in volume. Similar experiments on reflection with the gaseous tube previously mentioned was also conducted with equal success.

These tests show conclusively that these experimental short waves are only applicable when the transmitter and receiver are directly in the line of sight with no intervening conductive material present.

Regeneration in the Tuned R. F. Stage

SENSITIVITY and selectivity are the two main virtues of the superheterodyne. Without these, there is little doubt that the super would receive far less support than the older and simpler t.r.f. receiver. Regeneration has been employed in t.r.f. sets to increase their sensitivity and to some extent the selectivity, although the former is inevitably tied up with the latter. Regeneration in detector circuits of such receivers is a matter of common knowledge, and needs no explanation in this article. Suffice to say, however, that if this same form of regeneration could be included in the tuned r.f. stage, the sensitivity and selectivity of the simple t.r.f. set would increase considerably.

The lay constructor of short-wave receivers is often confronted with the problem of preventing the tuned r.f. stage from oscillating. In this article we propose to show how os-

cillation may be deliberately inserted and then *controlled*, so that maximum regeneration may be secured. This, however, cannot be accomplished by the simple process of inserting a tickler in the r.f. stage, for it is almost certain that the tuning of one stage will cause the second to break into undesired oscillation. The solution to this problem lies in the insertion of some device between the regenerative, tuned r.f. stage and the regenerative, tuned detector that will prevent interaction between the two circuits. One rather ingenious solution to this problem was presented by Sullivan and Kienle in the May issue of *QST*. Their idea is to insert an untuned buffer stage between the r.f. and the detector tubes. This buffer stage will allow signals to pass from the front to the rear end of the set, but not vice versa. This method, it seems to us, is extremely practicable

and may well be incorporated in existing regenerative receivers.

It is quite clear that, since the regenerative actions of both tubes are to be separate and distinct, the regenerative controls of both tubes should be entirely independent of each other. In fact, it is even suggested that the tuning controls be separate, although the gang condenser may be used, as will be mentioned later on.

A circuit similar to the one suggested by the authors of the previously mentioned article is shown in Fig. 1. The first tube is a 58; the buffer, a 24A; and the detector, a 24A. We now have a modernized version of the a.c. Super-Wasp. Note that the regeneration in the first r.f. stage is controlled by varying the screen voltage on this tube; the same applies for the controlled regeneration in the detector stage.

(Continued on page 41)

Regular Broadcasting on 7 Meters Through Buffalo Station

By Hamilton Woodle*

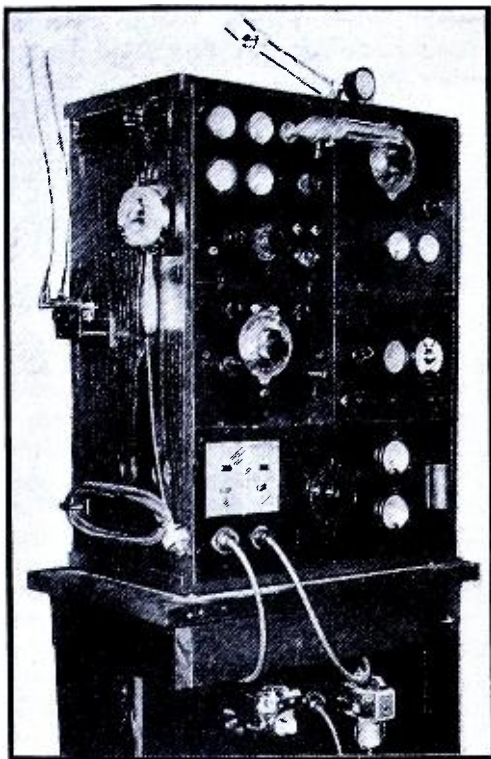

The complete W8XH station used for 7-meter broadcasting.

FOR the past two years, engineers of WBEN, Buffalo, N. Y., have been studying ultra short-wave transmission. Their study of the field strength of the W8XH transmitter has indicated that practically the same coverage can be obtained on the ultra-short waves as the average low power regional broadcasting station and with much less power in the transmitting antenna.

Considering these facts, it can be realized that ultra short-wave channels hold excellent possibilities for the broadcaster. The overcrowded broadcast band could be devoted entirely to high-power, clear-channel stations to be used for country wide coverage. The local or regional stations would be operated in the ultra short-wave band and would serve local city areas.

Other advantages which might be mentioned are freedom from static and fading. Also, transmission probably would be of higher quality, due to the wide frequency range employed.

Stations operating in the short-wave band need not be restricted to a channel ten kilocycles wide, but could be assigned a channel 15 or even 20 kilocycles wide. This would permit a full, rich, wide range of frequencies to be broadcast. Stations could operate on the same frequency without interference from each other, providing they were spaced approximately two hundred miles apart.

The W8XH transmitter is located in the downtown Buffalo district, on top of the Hotel Stätler, which gives the antenna a height of about 300 feet above ground level. The antenna is a $\frac{1}{2}$ -wave vertically polarized system, fed over a tuned two-

wire transmission line, seventy feet long. The transmitter was designed so that it could be used either for stationary or mobile work as the occasion might require. It is completely a.c. operated.

Incorporated as a part of the transmitter unit is an ultra short-wave receiver and a complete broadcast receiver. The broadcast receiver is used for a "starting cue" whenever the transmitter is employed for a remote pickup job for WBEN.

60-Mile Range Reported

Reports from listeners who are located as far as 60 miles from the transmitter denote that the signal is strong and does not fade. At such a distance, of course, the receiver must have a favorable location. Up to 25 or 30 miles, loudspeaker volume can be obtained in the average home with a vertical receiving antenna located on the second floor or in the attic and a single wire transmission line brought down to the receiver.

At the present time, W8XH is on the air an average of five hours a day, with programs of various types. Among these are a few which are just a little different than those carried by other Buffalo stations. The purpose of these unusual programs is to stimulate public interest. And public interest must be captured before any radio station is a success. Outstanding among these programs is broadcasting "On the Spot"—that is, putting a program on the air right from the point of origin by means of a portable transmitter, which eliminates the use of telephone lines. This assures the listener of accurate, up-to-the-minute information on important happenings.

Among the novel programs on W8XH: The 7-meter club, in which is presented a ten-piece orchestra, a soloist and a speaker, usually one

who is prominent in radio. His subject always is based upon short waves, and is delivered in as entertaining a manner as possible.

Many amateur radio operators, boy scouts and even ordinary listeners have become interested in the Continental Code Instruction Class conducted by our engineer, Ernest H. Roy. From him, over the air, they learn the code in much the same manner as at school. Another interesting feature is the Hobby Club of the Air; a program conducted by Harold Wallach, whose own hobby is collecting photographs of motion-picture stars, of which he has over 25,000. It is claimed that his is one of the largest collections in the United States. Every other Thursday, equipment is set up in Buffalo's City Hall and the council meeting is put on the air, with the city fathers debating before the W8XH microphone on the problems of the day. Short Wave Air Auditions are conducted each Monday morning and no one is denied the opportunity of singing a song, playing the piano, reciting or exhibiting any talent he may have.

Free Set Plans

For the present, the personnel or actual operating staff is limited, but we have a large list of talent, namely: an orchestra of ten men, a quartette called the "Harmony Four," an excellent accordionist, together with cellists, violinists, clarinetists, pianists, singers and lecturers, all of which makes for variety of programs. To further 7-meter broadcasting and to interest the layman who has not heard W8XH, there is one talk of five minutes duration weekly, in which ultra short-wave broadcasting is explained. Along with the talks goes the offer of free plans for building 7-meter receiving sets, which may be had for the asking.

Don't Fool With Sets' Insides!

INQUISITIVE owners of new all-wave receivers are cautioned against disturbing any of the numerous adjusting screws on the tuning condensers or the intermediate-frequency transformers (which are the round cans usually placed near the tubes) in an effort to boost the signal strength or otherwise increase the effectiveness of the sets. The setting of most of these little screws is pretty critical, and is performed in the factory only with the aid of complicated apparatus.

For routine service adjustments in the home, a dependable, calibrated oscillator is an absolute necessity.

This must generate miniature radio signals in the neighborhood of 115, 175 and 465 kilocycles, and also at several points in each of the short-wave and broadcast bands. While a short-wave experimenter who is continually building up and tearing down sets would find such an instrument a worthwhile investment, a "fan" listener certainly would not. If he suspects that his receiver is a bit "haywire," because of changed tubes, disturbed condensers or mechanical injury, the cheapest and best thing for him to do is to call in a service man with short-wave experience.

*Director, Station W8XH.

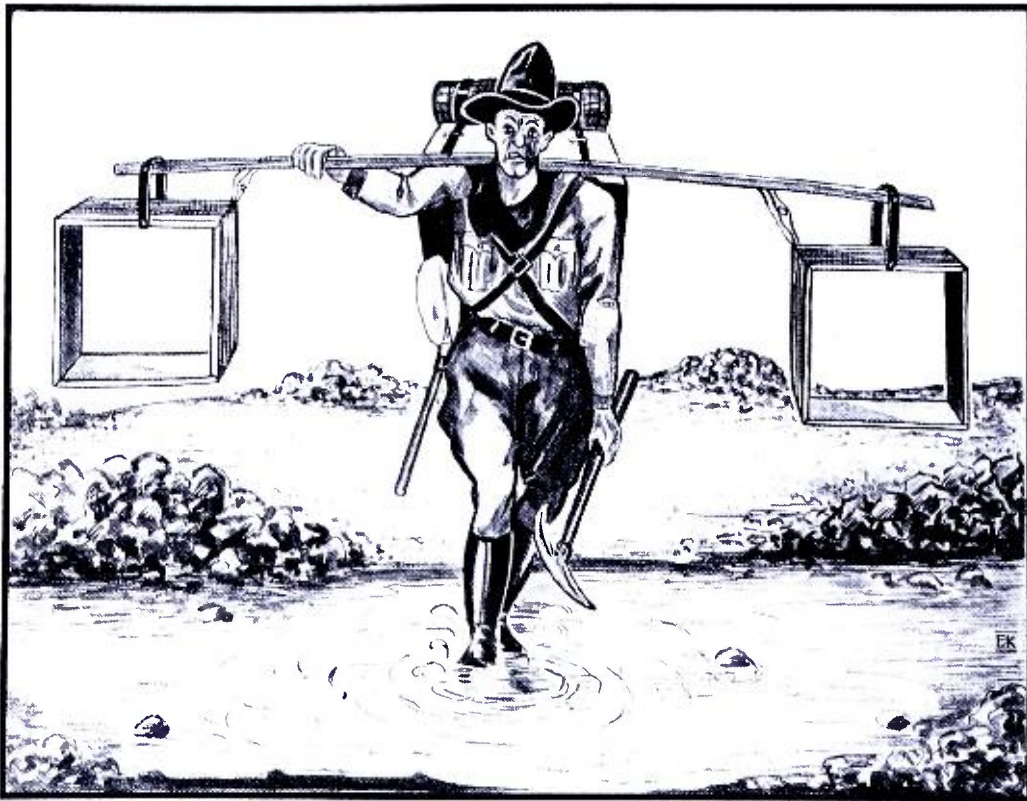

Our artist's conception of a radio-equipped prospector is not as exaggerated as it appears. The apparatus required is not simple or light, and it must be operated very carefully and accurately. The popular double-loop systems are especially critical.

The Truth About Radio "Treasure Finders"

By Louis Martin

THE lure of gold and easy money has always set the mercenary hearts of people beating just a little faster; and with the government paying about thirty-two dollars an ounce for newly mined gold, it is no wonder that prospectors who abandoned their profession years ago in favor of more profitable employment are again cleaning their sifters and returning to a business that is literally a "gold mine."

The price of gold, whether newly mined or not, is high enough to warrant the construction of thousands of "treasure" finders to facilitate the location of buried hoards of the precious metal. These people are perfectly serious in their quest for buried treasure. They either know where or have heard where quantities of the yellow metal have been stored, and they are making systematic searches for them.

The sincerity with which these treasure hunters are going after the easy money makes them ideal victims of manufacturers of "treasure finders," whose advertising claims and glowing reports easily convince the man anxious to go out and start mining or digging.

Mind you, we don't blame these people for wanting to excavate for gold or any other form of buried treasure; all we want to do is point out some of the pitfalls into which the untrained radio man can fall by

blindly purchasing a treasure finder. Then, too, we do not say that these devices do not work; indeed, practically all of them do work—but how? That is the question!

First of all, most of these metal locators (so called by some of the more conservative manufacturers) will locate anything from pieces-of-eight to rusty sewer pipes without the slightest bit of favoritism; in fact, the inability of metal locators to differentiate between a buried chest of gold and a discarded ash can is extremely disconcerting, to say the least. Any of the metal locators which are supposed to be capable of locating gold will locate *any* conductor of electricity with the same facility. This is the important thing to keep in mind when contemplating using one of these devices.

Another thing: the manufacturers of metal locators are usually located some distance from the points where the equipment is to be operated. This places the purchaser in a somewhat peculiar position. For one thing, he is unable to actually hear the apparatus work before plunking down his money; and secondly, if he is not satisfied with the device after he has purchased it, he usually has one sweet time trying to get his money back, simply because the manufacturer of the locator (or the firm that collects the parts for kits) is not, usually, a nationally known

concern. Bear these points in mind before handing out any gold to get gold!

Speaking of how well these metal locators work, a few remarks based on actual experience, will certainly not be amiss. In one particular instance, a pretentious looking metal locator, about six feet long and two feet deep was under test. Its designer claimed that it was capable of locating a bulk of metal about one-half a cubic foot in volume at a distance of about ten feet. To effect a reasonable test, an ordinary typewriter on a metal stand was placed in a room about fifteen feet square and the locator turned on. It was balanced according to Hoyle and brought near the typewriter. Nothing doing. The device refused to work at a distance of four feet. It was not until the typewriter was brought directly below the two coils of the locator that a sound was heard in the phones. Lo and behold! the typewriter was located at a distance of six inches, and we knew where it was *before* the test began. Whether or not the typewriter could have been found if it were completely hidden from sight is something that could not be ascertained.

Operator Unbalances System

Hundreds of these locators were built with indifferent success. By far the majority gave unsatisfactory results; some could only find material whose location was known, and some could not locate anything at all, save the operator. A few users reported good results.

The operation of these locators is usually such that the presence of the operator disturbs the system. Hence, the system must be balanced against the operator and against "ground." Changes in the position of either will throw the system out of balance in the same manner that a chest of gold will. In other words, unless the operator is particularly careful, his own presence will give an indication. When walking with the equipment in the act of locating the treasure, the apparatus naturally shifts from side to side and up and down. The up and down motion will, if the apparatus is sensitive enough, give an indication in exactly the same manner that a salt-water spring will. Even the best of apparatus will require several days of intensive study before it can be used with any degree of success.

Balance Method Used

There are many metal locator circuits, varying in complexity from the divining rod to elaborate oil-well locators requiring a ten-ton truck and a half dozen operators and mathematicians. Those usually offered for sale these days consist of some form of modulated oscillator and simple receiver separated several feet. Both the receiver and transmitter operate with loop aerials

which are rotated until no sound is heard in the receiver. When the device passes over a sufficiently large body of metal, the balance between the two loops is destroyed, and a sound is heard in the phones. A large body of metal deep in the ground will give about the same indication as a small body near the surface of the earth. You never can tell what, how much, or how deep the material is.

Bridge Type Popular

Then there are the many bridge types of systems. Two systems are set up in the form of a Wheatstone bridge and balanced over a homogeneous strip of ground. When the system passes over a bulk of metal the balanced bridge is unbalanced, and an indication is thus afforded of the presence of metal.

Another system recently in use involves the use of two oscillator circuits and a detector circuit which picks up the difference in frequency between the two oscillators—usually about 1000 cycles. The presence of metal changes the frequency of one or both of the oscillators, thus changing the frequency of the note heard in the phones. The apparatus is so constructed that one of the oscillators has a "finding coil," which is affected to a much greater extent than the second, or fixed oscillator. Hence, both oscillators are not changed by the same amount, which would result in no change in pitch in the phones.

Other considerations are of importance to the short-wave listener.

Effect of Frequency

Short-wave experimenters are especially concerned with this equipment, as most of the devices use high-frequency oscillators for operation. The higher the frequency, the more the distortion of the field. In one type of apparatus tested, a wavelength of 80 meters was used because it was the lowest wavelength that gave stable results. In still another device, 5 meter oscillators were set up on a tripod and the immediate surroundings surveyed—one spot was worked at a time.

The historians tell us—or at least imply—that piracy on the high seas and invasions of small towns in America was a very profitable, though quite illegitimate, business. It seems that the old buccaneers back in the 17th and 18th centuries who plundered the Spaniards for a living trusted no one, but carefully buried their loot and drew maps and charts of the burial grounds. Many of these "graveyards" still contain the plunder, and many people profess to know the actual location of one or more of them.

And so, if you or any of your friends have an inkling of where to look, and have decided to wield pick and shovel to relieve these graves of their burden, be sure that you have just as much faith in the "finder" as you have in the pirates.

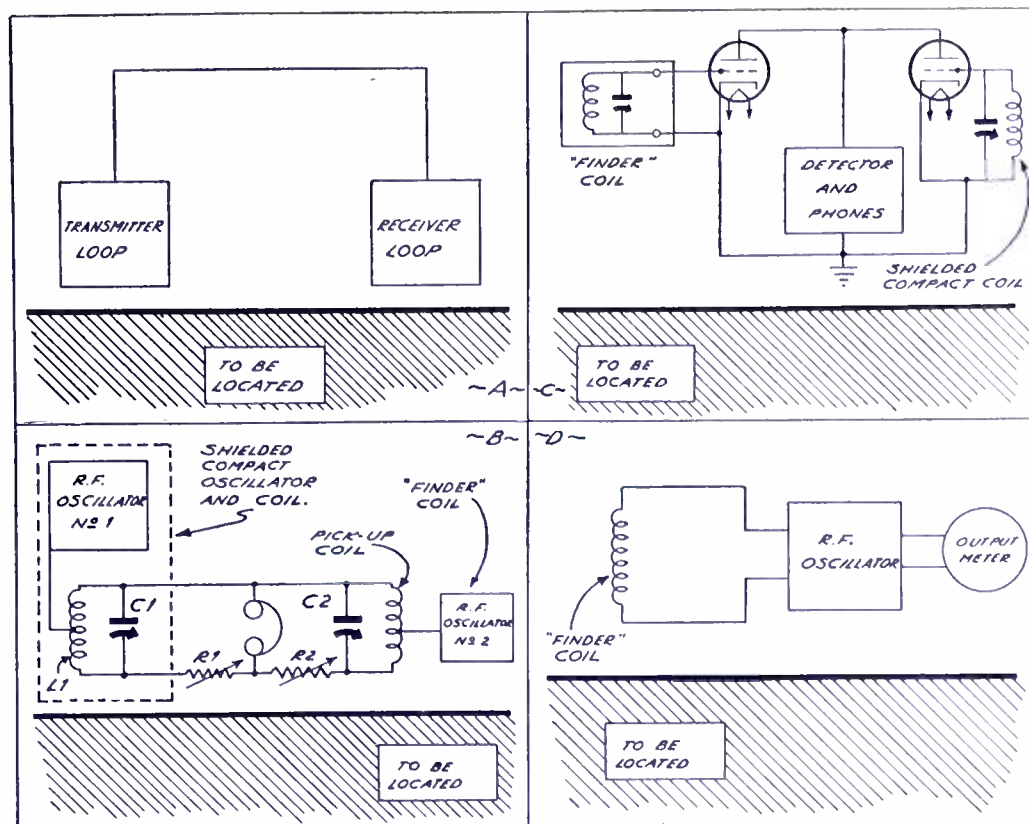

Four representative types of "radio treasure finders": A—the balanced loop type, comprising a complete radio transmitter and a receiver. B—the bridge type, employing two oscillators, one of which is thoroughly shielded. C—Beat frequency arrangement. D—Simple "disturbance" type, wherein the change of self-capacity of the finder coil causes the output-meter reading to change.

Byrd "Mailbag" Delivered Regularly

AFTER seven months of operation, the world's longest "air mail route" still seems to be standing ace-high with both the members of the second Byrd Antarctic expedition and their families and friends in the more temperate zones. The Byrd "mailbag," as it has come to be known, is broadcast regularly to Little America through the facilities of short-wave station W2XAF at Schenectady, N. Y. The studio pigeonholes have held some curious missives during this time, also, but each has been delivered as sent and to date no kicks have been registered by the recipients at the other end of the world.

Practical advice on various matters has become more the rule of late, crowding out the more routine comments on the weather and the penguins which predominated in early letters. Some time ago, when a member of the airplane crew was injured in a fall, W2XAF broadcast a prescribed treatment from a chiropractor on the Pacific Coast. Only recently, when it was made known that Admiral Byrd's flapjacks were sticking in the pan, seasoned advice on what to do about it was forthcoming from a number of housewives. The payment of insurance premiums and the buying and selling of stocks are also favorite subjects for communication. In other words, there is less emotional content and more real news.

Birthdays are the occasion for a flood of messages from relatives and friends and the broadcast takes on the semblance of a party. Bill McCormick, youthful autogiro pilot and

the youngest man on the expedition, attained his majority while at Little America. One of his messages of congratulation and advice traveled by a somewhat circuitous route, but it got there just the same. The writer, Wallace Kellett, autogiro manufacturer, penned the letter en route to France on the liner *De Grasse*. It was transferred to the liner *Olympic* for transmission back to New York, and W2XAF sent it on its way to Little America.

Since the formation of the ice party and the departure of ships and part of the expedition for New Zealand, considerable uncertainty as to just who was in Little America and who wasn't prevailed among families and friends. The conductors of the mailbag checked up on the personnel and dispatched to the folks at home a list of the 56 persons now enjoying temperatures of 70 degrees below zero at the camp, thus clearing up the situation.

The most striking feature of the short-wave broadcasts to date has been the practically perfect reception of the messages reported by the expedition. The listeners, totally enclosed by the Antarctic night, say that the voice of the broadcaster comes through as clearly as if it were in the next room.

It is doubtful if the transmission of short-wave letters and greetings is enjoyed any more by the men at the camp than it is by the senders themselves, to judge from letters written in to Schenectady. There are mothers and fathers to whom the late Sunday night broadcasts
(Continued on page 40)

Foreign Station Department



Conducted
by

J. B. L.
HINDS

Left: the author
at the controls
of his Hammar-
lund "Pro" short-
wave receiver.

On obtaining my verification, I received a very long and cordial letter from the station manager stating that on that particular night's broadcast he had received a great many reports of reception from long distances, one being from an operator on board a navy ship 1100 miles at sea, west of San Francisco. At other times I received other stations of low power with good volume and clearness, such as WMPC, Lapeer, Mich., 30 watts; KLCN, Blytheville, Arkansas, 7½ watts; WREC, Coldwater, Miss., 10 watts; KFWO, Catalina Island, off California, 250 watts; and various other 50- and 100- watt stations in remote corners of the country.

While it has always been my endeavor to obtain a second verification, there are many cases of this kind where you cannot turn the trick, as I know now that receiving it when you did was due only to the particular weather condition prevailing on the night in question. I find that this condition exists also in short-wave work, and this fact and others which I have gained brought me to the conclusion, long ago, that there is no such being as an "expert" listener. You may be an "expert" over your fellow listener by reason of your being fortunate or by reason of your patience and particular carefulness in tuning, but you would not be his superior were he to take the same interest as you did in the operation of his receiver. The answer simply is that some people *do things* and some *do things well*, and if you please to call the latter an expert, well and good.

Before I knew how broadcasts were handled by remote control, I used to marvel at hearing the shuffling feet and the merry laughter and conversation of the dancers on the floor of the Cotton Club in Los Angeles through the medium of station KTM at Santa Monica, on the shore of California, but while it is now interesting it is not "uncanny."

Early Results

Early in 1930 I purchased my first short-wave receiver while such stations as HRB, Tegucgalpa, Honduras; VRY, Georgetown, British Guiana; and G5SW Chelmsford were operating, but which have since been dismantled. I have heard stations on all continents and am No. 17 in the "Heard All Continents Club." I have nearly 200 verifications from short-wave stations in United States, Africa, Argentina, Australia, Bermuda, British Guiana, Bolivia, Brazil, Colombia, Canary Islands, Chile, Canada, Cuba, Costa Rica, Denmark, Dominica, Ecuador, England, France, Germany, Guatemala, Hawaii, Honduras, Holland, Hun-

DEEPLY appreciate the introduction given me by the editors of SHORT WAVE RADIO in the July number as the new conductor of the short-wave station department, and my aim will be to give its many readers conservative information.

As stated, I am not a radio technician, but am deeply interested in international DX reception. Radio has appealed to me for many years, having studied receiving conditions and followed DX reception for the past ten years, the first six years in long wave and the past four years in short-wave reception. While both long- and short-wave receiving are interesting, the short-waves appeal more to me due to the greater distance involved. I presume that a large percentage of owners of long-wave radio sets are of the opinion that an efficient operator in DX work on long waves would, at the beginning, be an efficient short-wave operator. This is not the case, as he will find conditions are considerably different in the respective waves, the short waves being much more elusive than the long waves until one knows his receiver and the peculiarities of the conditions attending its operation.

S.W. Sets More Sensitive

Short-wave receivers are far more sensitive than long-wave receivers and are much more subject to electrical interference of many sources, and this is natural, as short-wave receivers must be built along certain lines in order to bring in these distant signals. The electrical interferences of which I speak can be overcome to a certain extent, but not altogether. Some day, we hope to see a receiver which is immune to these interferences.

It was back in 1924 that I first owned a long-wave radio receiver, and during that year I first began to

hear DX reception and became fascinated by the "uncanniness" of radio, if you please. DX listening was then at its height, and I took up the sport with the rest because I really enjoyed it. And I am a firm believer that no one gets much out of a hobby unless he really receives pleasure in doing it, and doing it just a little better than some one else, or at least endeavoring to do so. In fact, we get out about what we put into anything. Is not that about true with life in general?

The Stamp Craze

It was late in 1924 that the EKKO stamp craze came to us. This stamp was similar to a postage stamp and bore the call letters of the radio station with the words "verified reception stamp." When received from the station, it was placed in a stamp album, which was subdivided by states and provided sufficient space for all radio stations. I possess one of these albums with nearly 700 stamps therein, covering stations in every state of the Union, every province in Canada and such near countries as Mexico, Puerto Rico, Cuba, Bermuda and Dominica. It was necessary, to secure one of these stamps, that you first give proof of having heard the station. I have always used a set of mimeographed forms for this purpose, and still use one in short-wave reception work. On account of all stations not using the EKKO stamp, I first obtained the verification on my form from the station and sent the verification to the EKKO Co. in Chicago, who returned my verification with stamp.

I found many unusual conditions in long-wave reception work which seemed strange to me, such as the picking up of a signal of a weak carrier, such as I did on the night of April 4, 1925, from WDBO, Winter Park, Florida, on 50 watts power.

gary, Italy, Indo-China, Java, Mexico, Nicaragua, Norway, Portugal, Philippine Islands, Spain, Switzerland, Soviet Republic, Vatican City and Venezuela. I have also heard the Byrd Expedition on numerous occasions and the Graf Zeppelin while she was out over the West Indies on her way in to America on her last trip here to the World's Fair, but of course have not received verifications for these broadcasts.

That Chinese Station

I note I am credited with not counting a station until I have a verification. I wish to modify that statement a little. I have in a few instances counted a station where I heard the call letters and location, etc., and where there was no doubt of the reception. I confess I did recently give out information that I heard CQN, Macao, China, and my only defense is that I announced it as various others did, but now there seems to be no doubt that all of us who thought we had the station on any Sunday were mistaken, as that station never has broadcast on Sunday, and the station we did have was H1X, in Dominica.

I received a very cordial letter from the Postmaster General at Macao from which I quote the following:

"Unfortunately, you have been unlucky, as our station never works on Sunday. CQN is the station of Macao, Portuguese colony, situated in South China, far from Hong Kong 40 miles and from Canton 80 miles. Power of station 500 watts when modulation in aerial is 100 per cent. At first we broadcast thrice a week on Mondays, Wednesdays and Fridays from 13:00 G.M.T. to 15:00 G.M.T. Since January 5, 1934, we opened at 12:00 G.M.T. to 14:00 G.M.T. and on March 12, 1934, program has been changed to twice a week, Mondays and Fridays 12:00 to 14:00 G.M.T., wavelength 49.8 meters."

In filing verifications, I file the envelope bearing the postmark and postage stamp and I prize my collection of stamps from the various countries, as I have some very unique ones. I am not a stamp collector, however. I have no doubt but that a great many listeners do likewise, and have a great many

unusual stamps from remote corners of the world. Speaking of verifications, many stations are sending out some very pretty cards in colors and shades. "La Voz Del Yaque" HI1A, Santiago de Los Caballeros, Dominican Republic, uses a printed post card bearing their call letters in large bright red across the face and printed matter, and containing the flag of the Republic in Red, White and Blue. The Australians, VK2ME and VK3ME, use many pretty colored cards of the Kookaburra bird, maps of Australia and outlying territory. The Vatican City station HJV sends many real photographic cards, one of the transmitter, towers and St. Peters and the Vatican grounds in the back ground being exceptionally unique. EAQ Madrid's latest card is done in black and blue on a white background; HJ4ABE, Medellon, Colombia, in green and black on white background. LSX, Buenos Aires, is red and black on a white background. Radio-Marc has a very pretty print of its transmitter buildings and towers. 2RO, Rome, Italy, is red and black on white background. CT1AA, Lisbon, Portugal, has a red, green and white card showing the studios and control rooms. HJ2ABA, Tunja, Colombia, has a card with a photograph of the station transmitter. YV1BC, Caracas, sends a booklet with verification on the cover, this booklet containing pictures of the transmitting plant, studios, artists, announcers, the descriptive portion describing the surrounding country. I have many others of an interesting character on which I might comment but will leave them for future articles.

Late Information

EAQ, Madrid, Spain, 30.40 meters, advises their hours of broadcasting (Eastern Standard Time) are daily 5.30 P.M. to 7.00 P.M. Sat-

urdays, special, 12 noon to 2.00 P.M. IBC programs every Saturday and Sunday 7.00 to 7.30 P.M. News items daily 5.15 or 5.20 to 5.30 P.M.

EA8AB (old call EAR58) Tenerife Radio Club, Sante de Cruz Tenerife, Canary Islands, is closed down temporarily. It is rebuilding with greater power and will be on a new wavelength other than 40.65 when it returns to the air.

Mexican Stations

XETE, Empresa de Telefonos Ericsson, Mexico DF., 6130 and 9600 kc., (48.94 and 31.25 meters) is on the air daily from 2 P.M. to 2 A.M. rebroadcasting long wave XEAL. Their address is P.O. Box 1396, Mexico D.F.

XEBT, about 49.80 meters, has verified my reception but does not give meters or time on the air. They are on late nearly every evening, close to DJC, and broadcast some fine programs, rebroadcasting long-wave transmitter XEB. Address, El Buen Tono, S. A. Mexico DF Apartado 79-44.

HIH, La Voz de Higuamo, San Pedro de Marcoris D. R., 15 watts, 43 meters, is said to be on the air daily 12.15 to 2 P.M. and on Thursday 10-11 P.M. At this writing have not picked them up.

For an efficient method of securing stations with a Comet Pro or similar band-spread receivers, try setting your oscillator dial at a given point (middle of the band) then track your wavelength dial with it and receive your stations in order by means of the band spread dial. It is surprising how easily it is done and how close they will come in each time on band-spread recordings. Some operators use the oscillator and wavelength dials alone in tuning, but in so doing are missing many weak stations and are not getting accurate calibration.

Right: reproduction of a "veri" received by Mr. Hinds from Italy. Below: the fancy acknowledgment card sent out by CT1AA, Lisbon, showing views of the station and studio.





"Italo Radio"

Società Italiana per i Servizi Radioelettrici
Sede in Roma Capitale - Sociale L. 300000000.

C. R. E. ROMA N° 10032

REF. _____

RIS. _____

Roma 11251 - April 8th 1934-XII
Via Calabria N° 19/48.

Segui il servizio di informazioni nelle risposte a scrivere un acknowledgment per lettera.

Mr. J. B. L. HINDS
85 St. Andrews Place
YONKERS, NEW YORK U.S.A.

In reply to your letters of March 17th and 18th we confirm both the logs of reception stated by you.

The speech you heard was our Premier Benito Mussolini's.

Thanks for reply postage coupon enclosed.

Yours truly

Esigete: Radiatore - Telefono: 46111 - 46112 - 46113 - 46114 - 46115 - 46116 - 46117 - 46118 - 46119 - 46120 - 46121 - 46122 - 46123 - 46124 - 46125 - 46126 - 46127 - 46128 - 46129 - 46130 - 46131 - 46132 - 46133 - 46134 - 46135 - 46136 - 46137 - 46138 - 46139 - 46140 - 46141 - 46142 - 46143 - 46144 - 46145 - 46146 - 46147 - 46148 - 46149 - 46150 - 46151 - 46152 - 46153 - 46154 - 46155 - 46156 - 46157 - 46158 - 46159 - 46160 - 46161 - 46162 - 46163 - 46164 - 46165 - 46166 - 46167 - 46168 - 46169 - 46170 - 46171 - 46172 - 46173 - 46174 - 46175 - 46176 - 46177 - 46178 - 46179 - 46180 - 46181 - 46182 - 46183 - 46184 - 46185 - 46186 - 46187 - 46188 - 46189 - 46190 - 46191 - 46192 - 46193 - 46194 - 46195 - 46196 - 46197 - 46198 - 46199 - 46200

for AUGUST, 1934

11

As a matter of information only— I am listing the average reception with the class of receiver I use for an evening (Friday in this case): EAQ, DJA, GSB, GSC, HJ1ABB, YV1BC, YV3BC, XEBT, YV5BMO, HJ5ABD, HJ3ABD, H11A, CT1AA, DJC, DJD, GSD, Pontoise (25.63), YV4BSG, PSK, HJ4ABE and Little America.

If requests are made I will gladly publish the dial settings by the method as outlined above, so comparisons may be made by operators of a band-spread receiver. The correspondence I receive from different parts of the country will materially assist in making this Department more interesting to readers, and the writer solicits comments, reception reports, etc., and will be very glad to make personal replies or through the medium of SHORT WAVE RADIO. Naturally my reports will cover Eastern reception. Reports from the West Coast would be of material value. As a matter of information to those on the West Coast, I might add that we receive the Bolinas transmitters and those in Hawaii with fine volume and clarity. The Columbia chain programs through Bolinas seem stronger than the locals here! If intimate information regarding particular stations is desired, it will be gladly furnished. In other words it is the thought and wish of the writer to make the Station Department your department and of vital interest to all readers.

Identifying Signals

FOREIGN short-wave broadcasting stations are notoriously dilatory about announcing their call letters, but, fortunately, many of them transmit peculiar interval signals that make their identification fairly easy. Even in cases where station call letters are given, the voice may be lost in a burst of static or may fade out inopportunely, but the interval signals may come through later quite clearly.

It is valuable to know, for instance, that stations PMC and PLF in Bandoeng, Java, on 16.56 and 16.81 meters respectively, transmit the sound of notes resembling a three-tone motor horn. This signal usually precedes an operator's call or a transmission of scrambled speech, these stations being engaged in radio telephone traffic between the Dutch East Indies and Holland. Similarly, the FW- group of stations at St. Assise, France, which communicate by telephone with Rabat, Morocco, and Argentina begin their transmissions with the code letter "F," following at intervals by the three musical notes, *la, fa, si*. Station LSY, in Buenos Aires, which will be found on 14.47, 16.55 and 16.7 meters, responds with *mi, mi, sol sharp and si*, as if played on a vibraphone.

The German station DFB, at Nauen, phones daily to Maracaibo,

85 St. Andrews Place,
Yonkers, New York, U. S. A.

_____, 19____

I have just had the pleasure of tuning in your station, and on the log below I am giving some of the selections I listened to. Will you be kind enough to check this with your station log and send me a verification of my reception.

Radio station _____
Date of reception _____
Volume _____
Tone quality _____
Interference _____
Atmospheric conditions _____

Log of reception as follows:
Time given in Eastern Standard Time

(SIGNED) _____
J. B. L. HINDS

Copy of a form used very successfully by Mr. Hinds in writing to foreign stations for verifications.

Venezuela, and Buenos Aires on 17.12 meters and announces itself by a three-tone whistle which sounds *re, do, sol*.

The station at Poznan, Poland, when it does broadcast on rare occasions, uses the easily recognized tick-tock of a metronome. So does the broadcasting station at Rabat, Morocco. Station CT1AA, Lisbon, Portugal, probably has the most unusual of all interval signals, which is the cuckoo call.

The peculiar cry of the kookaburra bird, or laughing jackass, is famous throughout the world as the identification of VK2ME in Sydney, Australia. Its sister station VK3ME, in Melbourne, has no particular signal, but opens its programs by transmitting clock chimes.

O. S. L. GOUVERNEMENT RADIO SERVICE BANDOENG, JAVA, DUTCH EAST INDIES.			
BROADCAST.			
	A	K.C.	Power
Every Tuesday from	14.60 m.	20,530	60 kw
With the transmitter $\varnothing R2$ and if possible $\varnothing R2V$ and $\varnothing R2Y$	15.93 m.	18,821	60 "
	16.56 m.	18,115	60 "
	31.86 m.	9,415	60 "
	58.3 m.	5,145	2 "

Reproduction of a rare card from the Dutch stations in the East Indies.

Details of OXY, Denmark

(The following description of station OXY, in Denmark, was received directly from the Danish government.)

THE short-wave station OXY is situated at Skamlebæk, on the western coast of the island of Zealand. At present it is broadcasting on a wavelength of 49.5 m. (6060 kc.). The power is 0.5 kw. From time to time it may, however, be working on 31.6 and 19.6 m.

The transmitter, which was inaugurated on November 13, 1928, comprises five stages, and is crystal controlled. In order to overcome the difficulties attendant upon the production and subsequent maintenance of crystal control at the very high frequency corresponding to 31.6 meters, a much lower frequency is employed in the initial or control stage and is doubled in succeeding stages, at the same time as the power is progressively increased. The modulation is applied via two tubes operated in parallel, the power in the aerial being 0.5 kw. under working conditions.

The power supply is obtained from two direct-current generators, one giving 0.6 kw. at 1,200 volts for the plates of the amplifying tubes, and the other delivering 3 kw. at 6,000 volts to the plates of the main transmitting and modulating tubes. Each generator is driven by an alternating-current motor. The tube in the crystal control circuit operates with a plate potential of 180 volts. Filament heating current for the last-mentioned tube, and for the first amplifying tube, is obtained from a storage battery; alternating current is used for the other tubes.

Rebroadcasts Other Stations

The OXY short-wave transmitter does not send its own programs, but it broadcasts the daily programs of the two other Danish stations, Copenhagen and Kalundborg, from 6.00 P.M. to about 11.30 P.M., GMT; that is, to the close of the Danish programs. Furthermore, the Sunday afternoon service at 4.00 P.M. (1.00 P.M., GMT, during the summer) is broadcast by the short-wave transmitter.

Rabat's Schedule

(Some time ago we sent letters to foreign stations for information. This is one of the early replies.—Ed.)

A letter received directly from Rabat, Morocco, advises that CNR, the short-wave station that relays the regular programs of the local broadcasting station "Radiodiffusion Radio Maroc," operates on Sundays and local holidays on the following schedule: 7.30 to 9.00 A.M., on 12,830 kc. or 23.32 meters; and 3.00 to 5.30 P.M., on 8035 kc. or 37.33 meters, Eastern Standard Time.

New World List of Stations

THE following list has been restricted as much as possible to stations that use radio telephony in one form or another. Among these are regular relay broadcasting stations, commercial point-to-point radiophones, and numerous experimental stations that use voice as well as code transmission, and are, therefore, understandable to any short-wave or all-wave set owner regardless of whether or not he knows the code.

This list has been compiled from many sources, which are not always in complete agreement. The licensing regulations in some countries are rather lax and influential station owners are known to pick their own call letters and operating frequencies, sometimes in defiance of international assignments. It is not

unusual to receive two different letters from the same Central or South American station during the one week, the letters giving altogether conflicting information!

The frequencies are given in megacycles rather than in kilocycles because the present trend is toward the use of the former unit. Readers accustomed to working with kilocycles can readily swing from kilocycles to megacycles, or vice versa, as the difference between the two units is merely a matter of the decimal point's position. Thus, 15.12 megacycles is the same as 15,120 kilocycles. The corresponding wavelengths in meters are given in all cases, as there are still many people, particularly "old timers" just getting back into the short-wave game, who still find it easier to think in

terms of meters than in kilocycles or megacycles.

For the benefit of new readers, we might mention that the following lists appeared in past issues of SHORT WAVE RADIO:

New Police Frequencies, arranged alphabetically by names of cities, page 11, June, 1934 issue.

World List of S. W. Broadcast Stations, arranged numerically according to frequency, page 12, May, 1934 issue.

Grand List of the S. W. Stations of the World, arranged alphabetically according to call letters, page 12, April, 1934 issue.

Back copies of these issues are obtainable directly from SHORT WAVE RADIO at the regular price of 25 cents each in stamps or coin. Please write your name and address clearly.

Mega-cycles	Meters	Call	Location	Dial	Dial	Mega-cycles	Meters	Call	Location	Dial	Dial	
60.20	4.98	W3XAY	Philadelphia, Pa.			25.70	11.67	W2XBC	New Brunswick, N. J.			
60.00	5.0	W3XE	Philadelphia, Pa.			24.00	12.50	W6XQ	San Francisco, Cal.			
		W6XAO	Los Angeles, Calif.			22.30	13.45	GBU	Rugby, England			
		W8XAN	Jackson, Mich.			21.54	13.93	W8XK	Pittsburgh, Pa.			
		W8XF	Pontiac, Mich.			21.47	13.97	GSH	Daventry, England			
		W8XL	Cuyahoga Hts., Ohio			21.46	13.98	W1XAL	Boston, Mass.			
		W9XE	Marion, Ind.			21.42	14.0	W2XDJ	Deal, N. J.			
		W1XW	Milton, Mass.			21.41	14.01	WKK	Lawrenceville, N. J.			
		W2XAK	New York, N. Y.			21.40	14.02	WLO	Lawrenceville, N. J.			
		W2XF	New York, N. Y.			21.16	14.17	LSL	Buenos Aires, Argen.			
		W2XR	Rocky Point, N. Y.			21.13	14.19	LSM	Buenos Aires, Argen.			
		W3XAD	Camden, N. J.			21.08	14.23	PSA	Rio de Janeiro, Brazil			
		W6XAO	Phoenix, Ariz.			21.06	14.24	KWN	Dixon, Cal.			
54.20	5.53	W3XAY	Philadelphia, Pa.					WKA	Lawrenceville, N. J.			
53.80	5.57	W3XAY	Philadelphia, Pa.			21.02	14.27	LSN	Buenos Aires, Argen.			
51.40	5.83	W6XAO	Phoenix, Ariz.			21.00	14.28	OKO	Podebrady, Czechoslovakia			
		W6XC	San Francisco, Cal.					LSY	Buenos Aires, Argen.			
		W8XAC	Lincoln Park, Mich.			20.73	14.47	FSR	Paris, France			
		W1XW	Milton, Mass.			20.68	14.5	LSN	Buenos Aires, Argen.			
48.50	6.18	W3XE	Philadelphia, Pa.					20.67	14.54	PMB	Bandoeng, Java	
		W6XAO	Los Angeles, Calif.					20.38	14.72	GAA	Rugby, England	
		W8XAN	Jackson, Mich.					20.04	14.97	OPL	Leopoldsville, Belgian Congo	
		W8XF	Pontiac, Mich.							DHO	Nauen, Germany	
		W8XL	Cuyahoga Hts., Ohio							LSG	Buenos Aires, Argen.	
		W9XE	Marion, Ind.							DIH	Nauen, Germany	
		W2XAK	New York, N. Y.							LSG	Buenos Aires, Argen.	
		W2XF	New York, N. Y.							WMI	Deal, N. J.	
		W2XR	Rocky Point, N. Y.							FTD	St. Assise, France	
		W3XAD	Camden, N. J.							CEC	Santiago, Chile	
48.20	6.22	W3XAY	Philadelphia, Pa.							IRW	Rome, Italy	
47.80	6.27	W3XAY	Philadelphia, Pa.							LSQ	Buenos Aires, Argen.	
43.00	6.97	W3XE	Philadelphia, Pa.							WOP	Ocean Gate, N. J.	
		W6XAO	Los Angeles, Calif.							WKN	Lawrenceville, N. J.	
		W8XAN	Jackson, Mich.							FTM	St. Assise, France	
		W8XF	Pontiac, Mich.							PPU	Rio de Janeiro, Brazil	
		W8XL	Cuyahoga Hts., Ohio							WKF	Lawrenceville, N. J.	
		W9XE	Marion, Ind.							DFA	Nauen, Germany	
		W1XG	Boston, Mass.							ORG	Brussels, Belgium	
		W2XAK	New York, N. Y.							WNC	Deal, N. J.	
		W2XF	New York, N. Y.							WKW	Rocky Point, N. Y.	
		W2XR	Rocky Point, N. Y.							GAG	Rugby, England	
		W3XAD	Camden, N. J.							LSR	Buenos Aires, Argen.	
42.20	7.10	W3XAY	Philadelphia, Pa.							HBF	Pragins, Switzerland	
41.80	7.17	W3XAY	Philadelphia, Pa.							PLE	Bandoeng, Java	
41.00	7.32	W1XW	Milton, Mass.							OCI	Lima, Peru	
		W2XV	Clifton, N. J.							GBU	Rugby, England	
		W6XC	San Francisco, Cal.							GAU	Rugby, England	
		W8XAC	Lincoln Park, Mich.							GBJ	Bodmin, England	
40.60	7.38	W2XV	Clifton, N. J.							VWY	Poona, India	
40.10	7.48	W2XV	Clifton, N. J.							DFB	Nauen, Germany	
38.60	7.77	W2XV	Clifton, N. J.							HJY	Bogota, Colombia	
37.60	7.98	W2XV	Clifton, N. J.							GAS	Rugby, England	
37.10	8.09	W2XV	Clifton, N. J.							PCK	Kootwijk, Holland	
35.80	8.38	W3XAY	Philadelphia, Pa.							PMC	Bandoeng, Java	
35.60	8.43	W2XV	Clifton, N. J.							WLA	Lawrenceville, N. J.	
34.60	8.67	W2XV	Clifton, N. J.							FZS	Saigon, Indo-China	
		W3XAR	Haverford, Pa.							GBS	Rugby, England	
		W2XAC	Lincoln Park, Mich.							YVR	Maracay, Venezuela	
		W2XES	Englewood, N. J.							FRE	St. Assise, France	
33.10	9.06	W2XV	Clifton, N. J.							FRO	St. Assise, France	
31.60	9.49	W2XV	Clifton, N. J.							CP5	La Paz, Bolivia	
31.10	9.65	W2XV	Clifton, N. J.							PLE	Bandoeng, Java	
30.20	9.93	W3XAY	Philadelphia, Pa.							CGA	Quebec, Canada	
30.10	9.97	W2XV	Clifton, N. J.									
27.80	10.79	W6XD	Palo Alto, Cal.									

Best Short Wave Stations

The list below has been compiled from various sources, which have been checked up as closely as the difficulties of international correspondence permit. While it is not 100% accurate (no s.w. station lists of any kind are!), it will be found very useful as a foreign station tuning guide.

It was drawn up by Mr. J. B. L. Hinds. The figures at the extreme left are wavelength in meters; next to them, frequency in megacycles. Readers are invited to send in additions or corrections based on their own reception experiences. Other readers will appreciate your help.

World wide stations that send programs: B, Broadcast; E, Experiment; P, Telephone stations.

Mega-Meters	Cycles	Call	Mega-Meters	Cycles	Call	Mega-Meters	Cycles	Call
EUROPE			ASIA			SOUTH AMERICA		
13.97	21.47	B, GSH, Daventry, England, 6.00 to 7.30 a.m.	16.50	18.18	P, PMC, Bandoeng, Java, 3.10-9.20 a.m.	19.19	15.62	P, OCJ, Lima, Peru, about 2 p.m., irregular.
16.30	18.40	P, PCK, Kootwijk, Holland, about 7.00 a.m.	19.03	15.76	E, JIAA, Kemikawa, Japan, 6.00-7.00 a.m.	25.73	11.66	E, PPQ, Rio de Janeiro, Brazil, 7-9.00 p.m., irregular.
16.88	17.77	B, PHI, Huizen, Holland, MWF 7.30-9.30 a.m., Sat. & Sun. 7.30-10.30 a.m.	20.03	14.98	P, KAY, Manila, Philippine Islands 5-7 a.m.—7-8 p.m.	27.35	10.97	P, OCL, Lima, Peru, 8-10 p.m., evenings, irregular.
19.68	15.25	B, Pontoise, France, 7 to 10 a.m.	30.40	9.87	E, JIAA, Kemikawa, Japan, 4-7 a.m.	28.98	10.35	E, LSX, Buenos Aires, Argentina, Thurs. and Sats. 8-10 p.m.
19.73	15.20	B, DJB, Berlin, Germany, 12.30 to 2.00 a.m., 6.35 to 9.45 a.m.	48.92	6.13	B, ZGE, Kuala Lumpur, Malaya States, Sun., Tues., Fri. 6.40-8.40 a.m.	30.30	9.90	P, LSN, Buenos Aires, Argentina, 6 p.m.-6 a.m., irregular.
19.82	15.13	B, GSF, Daventry, England, 6.00-7.30—8.40 to 11.00 a.m.	49.10	6.11	B, VUC, Calcutta, India, 9.30 a.m.-12 noon, Sat. 11.45 p.m. to 3.00 a.m.	36.65	8.19	B, PSK, Rio de Janeiro, Brazil, 6-7.30 p.m.
19.84	15.11	B, HVJ, Vatican City, Daily 5.00 to 5.15 a.m.—Sat. 10-10.30 a.m.	AFRICA			40.55	7.40	B, HJ3, ABD, Bogota, Colombia, 7.30-11 p.m.
25.00	12.00	B, RNE, Moscow, U. S. S. R., Sat. & Sun. Tests 9.00 & 10 a.m.	23.38	12.83	B, CNR, Rabat, Morocco, Sundays 7.30-9.00 a.m.	41.55	7.22	B, HKE, Bogota, Colombia, Monday 6-7 p.m., Tues., Fri. 8-9 p.m.
25.20	11.90	B, Pontoise, France, 10.15 a.m. to 1.15 p.m.—2.00 to 5.00 p.m.	29.58	10.14	P, OPM, Leopoldville, Belgian Congo, 9-11 a.m.—3-6 p.m.	41.60	7.20	B, HJ4AB, Manizales, Colombia, 8-10 p.m.
25.28	11.86	B, GSE, Daventry, England, 8.45 a.m.-12.45 p.m.	37.33	8.05	B, CNR, Rabat, Morocco, Sunday 2.30-5.00 p.m.	42.86	7.00	B, HJ1ABE, Cartagena, Colombia, Mon. 10-11 p.m., Wed. 8-10 p.m.; Sunday 9 a.m.-11 a.m.
25.40	11.81	B, 2RO, Rome, Italy, 11.30 a.m.-12.30 p.m.—1.15-6.00 p.m.	49.00	6.12	B, Johannesburg, 4.6 a.m.—8-10.30 a.m.—11 a.m.-3.40 p.m.	45.00	6.67	B, HC2RL, Guayaquil, Ecuador, Sun. 5.45-8.00 p.m., Tues. 9.15-11.15 p.m.
25.51	11.76	B, DJD, Berlin, Germany, 12.45-4.30 p.m.—9.00-11.30 p.m.	49.50	6.06	B, VQ7LO, Nairobi, Kenya Colony, 11 a.m.-2 p.m.	45.31	6.62	B, Prado, Riobamba, Ecuador, Thursday 9.00-11 p.m.
25.53	11.75	B, GSD, Daventry, England, 12.15-2.15 a.m.—1-8 p.m.	UNITED STATES			46.30	6.48	B, HJ5ABD, Cali, Colombia, 7-10 p.m.
25.63	11.71	B, Pontoise, France, 2.00-11 p.m.	16.87	17.78	B, W3XAL, Bound Brook, N. J., 7.00 a.m. to 1 p.m.	46.51	6.45	B, HJ1ABB, Barranquilla, Colombia, 6-10 p.m.
29.04	10.33	E, ORK, Brussels, Belgium, 1-5.00 p.m. irregular.	19.56	15.34	B, W2XAD, Schenectady, N. Y. M.W.F. 1.30-2.30 p.m., Sun. 1-3 p.m.	48.00	6.25	B, HJ3ABF, Bogota, Colombia, 7-11 p.m.
30.40	9.87	B, EAQ, Madrid, Spain, Daily 5.15-7.00 p.m., Sat. 12 noon-2.00, Sat. & Sun. 7.00-7.30 I.B.S.	19.64	15.27	B, W2XE, Wayne, N. J., 10 a.m.-12 noon.	48.78	6.15	B, YV3BC, Caracas, Venezuela, 10.30 a.m.-1.30 p.m., 4.30-9.30 p.m.
30.52	9.83	E, IRM, Rome, Italy, Afternoons, irregular.	19.72	15.21	B, W8XK, Pittsburgh, Pa. 9 a.m.-3.15 p.m.	49.08	6.11	B, YV1BC, Caracas, Venezuela, 10.30 a.m.-1 p.m., 5.15-10 p.m.
31.25	9.60	B, CTIAA, Lisbon, Portugal, Tues. & Fridays 4.30-7.00 p.m.	25.27	11.87	B, W8XK, Pittsburgh, Pa., 3.30-9.00 p.m.	49.20	6.10	B, HJ1ABD, Cartagena, Colombia, 11.30 a.m.-12.30 p.m., 7-9 p.m.
31.27	9.59	B, HBL, Geneva, Switzerland, Saturdays 5.30-6.15 p.m., Sun. same hours, irregular.	25.36	11.83	B, W2XE, Wayne, N. J., 2.00-4.00 p.m.	49.39	6.07	B, YV5BMO, Maracaibo, Venezuela, 7.30-10.30 p.m.
31.30	9.58	B, GSC, Daventry, England, 6.00-8.00 p.m.	31.28	9.59	B, W3XAU, Philadelphia, Pa., 11 a.m.-5.00 p.m., irregular.	49.60	6.05	B, HJ3ABI, Bogota, Colombia, 8-10 p.m. irregular.
31.38	9.57	B, DJA, Berlin, Germany, 6.45-9.45 a.m.—5.00-8.00 p.m.	31.36	9.57	B, WIXAZ, Boston, Mass., 6.00 a.m. to midnight.	50.08	5.99	B, YV4BSG, Caracas, Venezuela, 8.30-10.30 p.m.
31.55	9.51	B, GSB, Daventry, England, 12.15-2.15 a.m.—11 a.m.-12.45 p.m.—1-5.30 p.m.	31.49	9.53	B, W2XAF, Schenectady, N.Y., 6.45 to 10.00 p.m.	50.25	5.97	B, HJ2ABC, Cucuta, Colombia, 11 a.m.-12 noon, 6-9 p.m.
38.47	7.80	B, HBP, Geneva, Switzerland, Saturdays 5.30-6.15 p.m.—Sundays same hours, irregular.	46.69	6.43	B, W3XL, Bound Brook, N. J., Friday and Saturday 6.00-12 midnight.	50.42	5.95	B, HJ4ABE, Medellin, Colombia, Mon. 7-11 p.m., Tues., Thurs., Sat. 6.15-8 p.m., Wed., Fri. 7.30-10.30 p.m.
42.92	6.99	B, LCL, Jeloy, Norway, Relays Oslo 11 a.m.-6 p.m.	48.86	6.14	B, W8XK, Pittsburgh, Pa., 3.30 p.m.-1.00 a.m.	51.49	5.88	B, HJ2ABA, Tunja, Colombia, 1-2 p.m., 7.30-10 p.m.
43.86	6.84	B, HAS, Budapest, Hungary, 3.00-5.30 p.m.	49.02	6.12	B, W2XE, Wayne, N. J., 5.00-10.00 p.m.	73.00	4.00	B, HCJB, Quito, Ecuador, 7.30-9.45 p.m., except Monday.
45.38	6.61	B, REN, Moscow, U. S. S. R., 2.00-6.00 p.m.	49.18	6.10	B, W3XAL, Bound Brook, N. J., Mon., Wed., Sat., 4 p.m.-12 midnight.	MEXICO AND WEST INDIES		
49.40	6.07	B, OXY, Skamleback, Denmark, 2.00-6.30 p.m.	49.18	6.10	B, W9XF, Chicago, Ill., 3.30-7.30 p.m., 8.30 p.m.-1.30 a.m.	25.50	11.79	P, XDM, Mexico City, Mexico, 1-6 p.m., irregular.
49.83	6.02	B, DJC, Berlin, Germany, 12.50 to 4.30—9.00-11.30 p.m.	49.34	6.08	B, W9XAA, Chicago, Ill., 1-6 p.m. Sundays; week nights, irregular.	26.00	11.54	P, XAM, Merida Yucatan, Mexico, 1-6 p.m., irregular.
50.00	6.00	B, RV59, Moscow, U. S. S. R., 2.00-6.00 p.m.	49.50	6.06	B, W3XAU, Philadelphia, Pa., 7 p.m. to midnight.	31.25	9.60	B, XETE, Mexico City, Mexico, 6-10 p.m.
60.30	4.97	E, G6RX, Rugby, England, 8.00-10.00 p.m., irregular.	49.50	6.06	B, W8XAL, Cincinnati, Ohio, 6.30-10.30 a.m.; 1.30-3.30 p.m.; 6 p.m.-12 midnight.	47.50	6.32	B, HIZ, Santo Domingo, R.D., Daily 4.40-5.40 p.m., Sat. 11 p.m.-12.40 a.m.
69.44	4.32	E, G6RX, Rugby, England, 7.00-10.00 p.m.	49.67	6.04	B, WIXAL, Boston, Mass., 6.00-7 p.m.	(Continued on next page)		
			49.67	6.04	B, W4XB, Miami, Florida, Sat., 6.00-11 p.m.			

List of International Call Assignments

The international call letter assignments underwent some extensive changes early this year, when the acts of the Madrid Radio Convention of 1932 went into effect. For the most part the changes affect the smaller countries, but one really important shift gives all the R and U calls to the Union of the Soviet Socialist Republics, ("Russia"). The list as given below incorporates the official changes.

Block of Calls	Country	Amateur Prefix	Block of Calls	Country	Amateur Prefix
CAA-CEZ	Chile	CE		Bahamas	VP7
CFA-CKZ	Canada	VE		British Honduras, Trinidad	
CLA-CMZ	Cuba	CM			VP4
CNA-CNZ	Morocco	F		Jamaica	VP5
COA-COZ	Cuba	CM		Barbados	VP6
CPA-CPZ	Bolivia	CP		Bermuda	VP9
CQA-CRZ	Portuguese colonies:			Fanning Island	VQ1
	Cape Verde Ids.	CR4		Northern Rhodesia	VQ2
	Portuguese Guinea	CR5		Tanganyika	VQ3
	Angola	CR6		Kenya Colony	VQ4
	Mozambique	CR7		Uganda	VQ5
	Portuguese India	CR8		British Guiana	VR
	Macao	CR9		Malaya; Straits Settlement:	
	Timor	CR10			VS1, 2, 3
CSA-CUZ	Portugal:			Hongkong	VS6
	Portugal proper	CT1		Ceylon	VS7
	Azores	CT2	VTA-VWZ	British India	VU
	Madeira	CT3	VXA-VYZ	Canada	
CVA-CXZ	Uruguay	CX	W	United States of America:	
CYA-CZZ	Canada	VE		Continental United States	W
D	Germany	D		(for others, see under K.)	
EAA-EHZ	Spain	EA	XAA-XFZ	Mexico	X
EIA-EIZ	Irish Free State	EI	XGA-XUZ	China	XT, XU
ELA-ELZ	Liberia	EL	XYA-XZZ	British India	VU
EPA-EQZ	Persia	EP	YAA-YAZ	Afghanistan	YA
ESA-ESZ	Estonia	ES	YBA-YHZ	Dutch East Indies	PK
ETA-ETZ	Ethiopia (Abyssinia)	ET	YIA-YIZ	Iraq	YI
EZA-EZZ	Saar Territory	EZ	YJA-YJZ	New Hebrides	YJ
F	France	F	YLA-YLZ	Latvia	YL
	France, Algeria, Martinique,		YMA-YMZ	Danzig	YM
	Morocco and Tahiti	F3, F8	YNA-YNZ	Nicaragua	YN
G	United Kingdom:		YOA-YRZ	Roumania	CV
	Great Britain except Ireland	G	YSA-YSZ	Republic of El Salvador	YS
	Northern Ireland	GI	YTA-YUZ	Yugoslavia	UN
HAA-HAZ	Hungary	HA	YVA-YWZ	Venezuela	YV
HBA-HBZ	Switzerland	HB	ZAA-ZAZ	Albania	ZA
HCA-HCZ	Ecuador	HC	ZBA-ZJZ	British colonies and protectorates	
HHA-HHZ	Haiti	HH		Transjordan	ZC1
HIA-HIZ	Dominican Republic	HI		Palestine	ZC6
HJA-HKZ	Colombia	HJ, HK		Nigeria	ZD
				Southern Rhodesia	ZE1
			ZKA-ZMZ	New Zealand:	
				Cook Ids.	ZK
				New Zealand proper	ZL
				British Samoa	ZM
			ZPA-ZPZ	Paraguay	ZP
			ZSA-ZUZ	Union of South Africa	ZS, ZT, ZU
HPA-HPZ	Republic of Panama	HP			
HRA-HRZ	Honduras	HR			
HSA-HSZ	Siam	HS			
HVA-HVZ	Vatican City State				
HZA-HZZ	Hedjaz	HZ			
I	Italy and colonies	I			
J	Japan	J			
K	United States of America:				
	Continental United States	W			
	Philippine Ids.	KA			
	Puerto Rico and Virgin Ids	K4			
	Canal Zone	K5			
	Territory of Hawaii, Guam and Samoa	K6			
	Territory of Alaska	K7			
LAA-LNZ	Norway	LA			
LOA-LWZ	Argentine Republic	LU			
LXA-LXZ	Luxemburg	LX			
LVA-LYZ	Lithuania	LY			
LZA-LZZ	Bulgaria	LZ			
M	Great Britain	G			
N	United States of America	W			
OAA-OCZ	Peru	OA			
OEA-OEZ	Austria	OE			
OFA-OHZ	Finland	OH			
OKA-OKZ	Czechoslovakia	OK			
ONA-OTZ	Belgium and colonies	ON			
OUA-OZZ	Denmark	OZ			
PAA-PIZ	The Netherlands	PA			
PJA-PJZ	Curacao	PJ			
PKA-POZ	Dutch East Indies	PK			
PPA-PYZ	Brazil	PY			
PZA-PZZ	Surinam	PZ			
R	Union of the Soviet Socialist Republics	R			
SAA-SMZ	Sweden	SM			
SOA-SRZ	Poland	SP			
STA-SUZ	Egypt	ST			
SVA-SZZ	Greece	SV			
TAA-TCZ	Turkey	TA			
TFA-TFZ	Iceland	TF			
TGA-TGZ	Guatemala	TG			
TIA-TIZ	Costa Rica	TI			
TKA-TZZ	France and Colonies and Protectorates	F			
U	U.S.S.R.	U			
VAA-VGZ	Canada	VE			
VHA-VMZ	Australia	VK			
VOA-VOZ	Newfoundland	VO			
VPA-VSZ	British colonies and protectorates	V			
	Fiji, Ellice Islands, Zanzibar	VPI			

Arctic-to-Antarctic S. W. Link to be Attempted

ASPECTACULAR attempt to link the Arctic and the Antarctic in a two-way radiophone exchange for the first time will be made by the Columbia Broadcasting System early in July. Preparations to "bring together" the northern and southern extremities of the earth have been in progress for many months and only final details

remain to be worked out. July 11 has tentatively been set as the day for the broadcast as part of the regular Wednesday night Byrd program.

The Antarctic termination for the 17,000-mile circuit will be station KFZ, CBS unit at Little America. A temporary Columbia station in northwestern Alaska, above the

Arctic Circle, will be the voice of the far north. A license to operate this special outlying unit has been granted by the Federal Radio Commission.

Signals from the CBS-Arctic station will be carried by short waves to the RCA station at Point Reyes, near San Francisco, a distance of nearly four thousand miles. From the northern California metropolis, regular CBS transcontinental facilities will be employed to bring the Arctic voices to New York, whence they will be relayed to the Byrd Expedition over the Rocky Point, L. I.-Little America circuit employed for the Wednesday broadcasts. This route will be reversed, with the addition of another relay point at Buenos Aires, to carry the voices of Byrd's men to the Land of the Midnight Sun.

Robert Flagler, Seattle broadcast and telephone engineer, will have charge of Columbia's temporary Arctic unit. Not only will he serve as manager and engineer of this station, but also will be called upon to fill the functions of program director, announcer, continuity writer and every other staff position of a

(Continued on page 43)

Best Short Wave Stations

(Continued from previous page)

Mega-Meters	Cycles	Call	Mega-Meters	Cycles	Call
47.80	6.23	B, H11A, Dominican Rep., Daily 12.10-1.40 p.m., 7.40-9.40 p.m., Sun. 1.40-4.40 p.m., 7.40-9.40 p.m.			
49.50	6.06	B, H1X, Santo Domingo, R.D., Tues. & Fri. 8.10-10.10 p.m., Sun. 8.40-10.40 a.m., 2.40-4.40 p.m.			
49.96	6.01	B, COC, Havana, Cuba, 4-6 p.m., 8-10 p.m.			
OCEANIA					
31.28	9.59	B, VK2ME, Sydney, Australia, Sun. 1-3.00 a.m., 5.00-9.00 a.m., 11.30 a.m. to 1.30 p.m.			
31.30	9.58	B, VK3LR, Melbourne, Australia, Daily except Sun. 3.30-7.45 a.m.			
31.55	9.51	B, VK3ME, Melbourne, Australia, Wed. 5.00 to 6.30 a.m., Sat. 5 to 7 a.m.			
CANADA					
25.60	11.72	CJRX, Winnipeg, Manitoba, Daily 6-10.30 p.m., Sun. 9-10 p.m.			
49.10	6.11	B, VE9HX, Halifax, N. S., 8.30-11.30 a.m., 5-10 p.m.			
49.22	6.09	B, VE9GW, Bowmanville, Ont., Mon., Tues., Wed. 1-10 p.m., Thurs. 2-11 p.m., Fri., Sat. 6.00 a.m.-11 p.m., Sun. 10 a.m.-7 p.m.			
49.29	6.09	B, VE9BJ, St. John, N. B., 5-10 p.m., irregular.			
49.42	6.07	B, VE9CS, Vancouver, B. C., Fri. 12.30-1.45 a.m., Sun. 12 noon-midnight.			
49.96	6.01	B, VE9DN, Drummondville, Que., Saturdays after 10.30 p.m.			

Reception Reports From Readers

BECAUSE the United States is a big country, reception conditions on the short waves are bound to be different in different sections. For this reason, we ask readers to send in detailed reports of their experiences. Extremely interesting data have been brought to light in some of the letters we have published. This department has caused many short-wave listeners to start corresponding with each other, and some fine friendships have been built up.

If you have been keeping a log of your results (and every listener should), by all means send us a sort of review of it for a period of, say, a month. Don't fail to mention your receiver and to describe your aerial. Use a typewriter if you have one; otherwise, please write clearly in ink on one side of the paper.

Wardner, British Columbia

Editor, SHORT WAVE RADIO:

SHORT WAVE RADIO is a fine magazine for s.w. listeners and I am sure that I am one who will support it to the utmost. Articles on short-wave receivers and those pertaining to short waves are printed in such a manner that the majority of your readers should have no trouble in understanding them thoroughly.

Wardner is situated in the southeast corner of the province of British Columbia, approximately 350 miles from the Pacific Ocean and 30 miles from the International Boundary; the elevation is nearly 2600 feet above sea level.

I suppose it would not be amiss to give conditions of reception from the most westerly province of Canada. My receiver is a two-tube affair using type 199 tubes, regenerative detector and one stage of audio. The antenna is of the inverted "L" type, single wire, 130 feet long and 45 feet above the ground. I built this "junk box" receiver in 1931, but did not use it a great deal until a year ago, the cause being lack of interest in short-wave reception. But now I am an ardent "short-waver."

Here is a list of stations that I have received on the above mentioned receiver. I will not list Canadian, U. S., or commercial phone stations. I might also state that most of the stations are verified.

XETE, Mexico City; T14NRH, Heredia, Costa Rica; YV1BC, Caracas, Venezuela; YV3BC, Caracas, Venezuela; HJ1ABB, Barranquilla, Colombia; HJ4ABB Manizales, Colombia; HC2RL, Guayaquil, Ecuador; PRADO, Riobamba, Ecuador; PSK, Rio de Janeiro, Brazil; LSX, Buenos Aires, Argentina; GSA, GSB, GSC, GSD, GSE, GSF, Daventry, England; Pontoise, France, on three wavelengths (19.68 m., 25.2 m. and 25.6 m.); DJA, DJB, DJC, DJD,

Berlin, Germany; HBL, HBP, Geneva, Switzerland; CT1AA, Lisbon, Portugal; EAQ, Madrid, Spain; 12RO, Rome, Italy; RV59 and RNE, Moscow, Russia, (USSR); RV15, Khabarovsk, Siberia; VK2ME, Sydney, Australia; and VK3ME, Melbourne, Australia.

GSF, Daventry, England, was received well here around 11 P.M. last summer, and at present 20 meter "phones" are received well until 11 P.M., M. S. T.

I will be glad to exchange correspondence with any short-wave listener who cares to write me.

Very truly yours,
WILLIAM M. SINCLAIR,
Wardner, B. C., Canada.

Mobile, Alabama

Editor, SHORT WAVE RADIO:

I have been a reader of your magazine since its first issue, and have found it very interesting and helpful; your articles about foreign short-wave stations, such as identifying signals, frequencies, etc., have been of service in enabling me to tune in stations heretofore not heard.

I have been interested in the high frequencies (from a receiving standpoint), since December 1931, and have constructed several small (two- and three-tube 2 volt) receivers. Just as a matter of information, I attach a list of stations tuned in during part of the day May 8th, while the writer was at home. Conditions here have been very good for receiving, but static is now beginning to be noticed, and on the South American stations there is always interference of some degree.

I have not received many of the stations to the West; have had both the Australian stations (VK2ME and VK3ME) on several occasions, and Hawaiian Island commercial stations. On a recent Sunday morning, at 4:45 A.M.-5:30 A.M. (Central Standard Time), I tuned in a station somewhere between 40 and 45

One Day's Reception— May 8th, 1934

7:30 A.M.	W1XAZ	31.35 meters
1:45 P.M.	I2RO	25.5 "
1:50 P.M.	W2XE	25.36 "
2:00 P.M.	FYA	25.53 "
5:46/6:00 P.M.	GSD	25.5 "
5:44 P.M.	W8XK	25.26 "
6:16/6:26 P.M.	W2XAF	31.48 "
6:30 P.M.	W3XAU	31.28 "
6:30 P.M.	XETE	31.25 "
6:49 P.M.	W2XE	49.02 "
7:00 P.M.	W8XK	48.86 "
7:05 P.M.	YV3BC	48.78 "
7:30 P.M.	DJC	49.83 "
7:30 P.M.	W9XF	49.18 "
7:30/7:45 P.M.	W9XAA	49.31 "
7:49/8:32 P.M.	YV5BMO	49.42 "
9:00 P.M.	VE9GW	49.22 "

meters, that was either Japanese or Chinese, from the announcer's language and the singing of a man with apparently a single-stringed instrument accompanying. It may be due to the position of my aerial that stations to the East and South seem to be received with better volume and more consistency.

Am glad to note from your June issue, that you expect to expand the department covering foreign program notes of interest and this will be looked forward to with anticipation.

W. C. DUKES, JR.,
Box 446,
Mobile, Alabama.

New Bedford, Mass.

Editor, SHORT WAVE RADIO:

I saw your request for reports of reception in different sections of the country. Here is a sample. Looking in your list of stations I saw EAQ. I tuned it in. Here are the results:

April 21—QSA3-4/R6/N/XX

April 29—QSA4/R9/N/NX

May 3—QSA3/R9/S/XX

May 5—QSA4/R9+/S/NX

May 9—QSA5/R9+/N/NX

The following list explains the meaning of the letters in the list above:

S—slight fading

SS—deep fading

SSS—complete fade-out

R—rapid fading

N—no fading

X—slight static

XX—rather bad static

XXX—very heavy static

NX—no static

I am using a Midwest 8 tube All Wave Set. My aerial is an outside single wire type. I have in the attic three small aerials—one 6 feet long, pointing NW., one 8 feet pointing ENE., and one 13½ feet with lead in at the center pointing N. & S. Beside my set I have switches to change aerials. My list consists of 773 stations, 77 of which are foreign. The best ones are all American (except W2XAD), VE9GW, VE9HX, VE9DR, VE9JR, LSX, LSY, YV5BMO, DJA, DJB, DJC, DJD, all British; HBL, HBP, VKZME, HIZA, HJ4ABB, HC2RL, YVQ and many others.

Very truly yours,
EARL D. COLLINS,
114 Carroll St.,
New Bedford, Mass.

Bronx, N. Y.

According to a verification received by Mr. A. L. Mainhofer, 1898 Billingsley Terrace, Bronx, N. Y., the new identifying signal of the Vatican City station HVJ is the Bells of St. Peters, at the start of each broadcast. During the programs the ticks of the studio clock

continue to be heard, as previously.

We are also indebted to Mr. Mainhofer for the following copy of a letter received by him from Bermuda.

Hamilton, Bermuda.

Dear Sir:

Your kindness in writing to tell us of the reception of our short-wave radio broadcast of the St. George's Day celebrations, which took place at the old town of St. George, Bermuda, on the 23rd of April, is greatly appreciated. This was our first official radio broadcast from Bermuda by short waves only, and we are delighted with the success achieved.

As a memento of the occasion, and a small token of our appreciation of your kind interest, we are sending to you under separate cover, a photograph of King's Parade (ofttimes called "Market Square"), St. George, which was taken on April 23rd and shows the celebrations taking place and the crowd gathered to witness them. We are also sending an attractive handbook on Bermuda and a copy of the illustrated booklet by our Government.

For your records we are pleased to advise that the broadcast was made on a frequency of 10,335 kilocycles or 29.02 meters, the symbol of which is ZFB.

Again thanking for your cooperation.

Cordially yours,
JOSEPH J. OUTERBRIDGE,

Secretary,
The Bermuda Trade Development Board.

The highly popular short-wave broadcasting station in Caracas, Venezuela, is now operating with the call letters YV2RC. The frequency remains the same, 6112 kc., or 49.8 meters. This information is contained in a letter dated May 15, 1934, and signed by Edgar J. Anzola, director.

Complete Schedules of Daventry Stations

As the British Broadcasting Corporation maintains eight separate short-wave stations for its far flung "Empire Broadcasting Service," and American listeners are always get-

ting them mixed up, we are printing herewith an entire operating schedule, which includes all call letters, wavelengths, frequencies and hours. This chart is worth saving.

EMPIRE STATION WAVELENGTHS

From May 27

The Empire Transmitters at Daventry can work simultaneously on any two of the waves shown in the following table. The waves shown for each transmission are those most commonly employed, but those actually in use at the time of despatch of this schedule are printed in italics.—Ed.

The alternative frequencies in the 31 (GSB and GSC) and 25 (GSD and GSE) meter bands may be used at short notice.

The actual waves in use may be altered from time to time consequent upon changing seasonal conditions and reception reports which are received from Empire Station listeners overseas.

TRANSMISSION	Call Sign	Frequency kc.	Wavelength meters	Times of Transmission	G.M.T.	E.S.T.
No. 1	GSF	15140	19.82	16 Dec.-19 Jan. (1935) Until 17 Feb. & 11 Nov.-15 Dec. 18 Feb.-17 Mar. & 7 Oct.-10 Nov. 18 Mar.-14 Apr. & 2 Sep.-6 Oct. 15 Apr.-12 May & 29 July-1 Sept. 13 May-28 July	08.30-10.30	3.30-5.30 A.M.
	GSE	11865	25.28		08.00-10.00	3.00-5.00 A.M.
	or GSD	11750	25.53		07.15-09.15	2.15-4.15 A.M.
	GSC	9585	31.30		06.15-08.15	1.15-3.15 A.M.
	or GSB	9510	31.55		05.15-07.15	12.15-2.15 A.M.
	GSA	6050	49.59		04.30-06.30	11.30-1.30 A.M.
No. 2	GSH	21470	13.97	11.00-13.30 G.M.T. (11.30-13.30 Sundays)	6.00-8.30 A.M.	E.S.T.
	GSG	17790	16.86		6.30-8.30 A.M.	E.S.T.
	GSF	15140	19.82			
	GSE	11865	25.28			
	or GSD	11750	25.53			
No. 3	GSG	17790	16.86	13.45-17.45 G.M.T. When three call signs are in italics, the middle wavelength will be used for the whole period. The time of change from the shortest to longest wave length underlined will be 15.45 G.M.T.	8.45 A.M.-12.45 P.M.	E.S.T.
	GSE	15140	19.82			
	GSE	11865	25.28			
	or GSD	11750	25.53			
	GSC	9585	31.30			
	or GSB	9510	31.55			
	GSA	6050	49.59			
No. 4	GSF	15140	19.82	18.00-22.30 G.M.T. When three call signs are in italics, the middle wavelength will be used for the whole period. The time of change from the shortest to longest wavelength underlined will be . . . G.M.T.	1.00-5.30 P.M.	E.S.T.
	GSE	11865	25.28			
	or GSD	11750	25.53			
	GSC	9585	31.30			
	or GSB	9510	31.55			
	GSA	6050	49.59			
No. 5	GSF	15140	19.82	23.00-01.00 G.M.T. 6.00-8.00 P.M. E.S.T.		
	GSE	11865	25.28			
	or GSD	11750	25.53			
	GSC	9585	31.30			
	or GSB	9510	31.55			
	GSA	6050	49.59			

Always listen for announcements, because wavelengths, programs and times are liable to change.
The British Broadcasting Corporation, Broadcasting House, London, W. 1.

Latest Data on American and Foreign S. W. Broadcasters

WE have written hundreds of letters to short-wave stations all over the world in an effort to obtain authentic data on their activities. Answers have started to drift back, and we are publishing this month's accumulation herewith for the benefit of all listeners.

VE9CS, Vancouver, B. C.

"With reference to your request for particulars regarding VE9CS, our time schedule is as follows:

Daily, 3:00 to 4:30 P. M.

Tuesday, 3:00 to 4:30 P. M. and 8:30 to 10:30 P. M.

Sunday, 10:45 A. M. to 6:00 P. M., and 7:30 to 10:00 P. M. All times Pacific Standard Time.

"Our frequency is 6070 kc., and

output power varies from two to ten watts."

RADIO SERVICE ENGINEERS LTD.,
734 Davie Street,
Vancouver, B. C.

Dixon, California

"In reply to your letter addressed to our Dixon, California, station, this company is operating but one radio transmitter. It is located at Dixon with its companion receiving station at Point Reyes, Cal. These stations serve as the U. S. terminal of the radio telephone circuits which extend Bell System telephone connections to points in Hawaii, the Philippines, Java and to certain ships in the Pacific. Tests are also in progress with a view to extending service to Japan in the near future.

"The normal output of the transmitter is approximately 20 kw. Directional antennas are used as required. The assigned frequencies and call letters are as follows:

KWN, 21060 kc.; KWO, 15415 kc.; KWU, 15355 kc.; KWV, 10840 kc.; KWX, 7610 kc.; KWY, 7565 kc.

R. N. NICELY,

Plant Superintendent,
Transpacific Communication Company, Ltd., 32 Sixth Avenue, New York, N. Y.

W2XE, Wayne, N. J.

Short-wave station W2XE, which operates in conjunction with WABC, key station of the Columbia Broadcasting System, works on 15,270 kc. from 11:00 A. M. to 1:00 P. M.; on
(Continued on page 39)

Terrestrial Magnetism and Short-Wave Radio

FOR many years it has been known that a relation exists between terrestrial magnetism and the propagation of short-wave signals. Reception of distant short-wave signals becomes difficult during a severe magnetic storm.

Back in 1928, R. C. A. Communications, Inc., and the National Broadcasting Company inaugurated a joint program for regularly receiving foreign short-wave broadcasting stations at Riverhead, L. I. In addition to the data obtained from the Riverhead observations, reception reports were received from the General Electric Company and the Westinghouse Electric and Manufacturing Company. During 1928 and 1929, a considerable number of reception reports were also received from the British Broadcasting Corporation of England and Philips Radio of Holland, and during 1929 and 1930 from the Reichs-Rundfunk-Gesellschaft of Germany. These foreign reports covered reception

primarily in those three countries of North American stations.

These data were carefully studied by the National Broadcasting Company, and the correlation of magnetic activity with reception yielded some very interesting information which was published by Messrs. R. M. Morris and W. A. R. Brown of the National Broadcasting Company in the Proceedings of the Institute of Radio Engineers for January, 1933, in a paper entitled "Transoceanic Reception of High Frequency Telephone Signals."

One of the most interesting conclusions reached by Morris and Brown was that the magnetic disturbances which influence short-wave reception tend to occur at intervals of approximately 27 days, thereby making it possible to predict reception conditions with a sufficient degree of accuracy to be very useful.

R. C. A. Communications, Inc., has a great volume of data in the form

of radio telegraph logs taken over a period of years, and a study of some of these data in relation to magnetic disturbances was undertaken by Mr. H. E. Hallborg. This study showed a useful degree of correlation confirming and extending the studies of Messrs. Morris and Brown.

It seemed evident that predictions for short-wave reception conditions similar in accuracy to the usual weather forecasts might be expected. Since the weather man seems to miss his predictions occasionally, we believe we are justified in thinking that we can predict the conditions for short-wave reception two to four weeks in advance with about equal accuracy.

Basis of Predictions

The predictions are based on the repetition of magnetic storms in a cyclic sequence. The disturbances are more or less related to sun-spot activity, and the rotation of the sun apparently provides the cyclic sequence of magnetic storms.

Perhaps the best way to explain this repetition of magnetic storms is to refer to Fig. 1, which shows one of Mr. Hallborg's charts of magnetic activity taken from magnetograms furnished by the Government Observatory at Tucson, Arizona.

On this chart, ordinates are magnetic range, one scale division representing 30 gammas. If the magnetic range extends beyond 60 gammas, we have found by experience that this range is sufficient to disturb the reception of short-wave signals. Accordingly, all ranges above 60 gammas have been filled in with black ink to make it instantly apparent, in looking at the chart, where the disturbing magnetic conditions lie.

27-Day Cycle

It may also be noted that the abscissa extends from 1 to 27, indicating that the magnetic ranges are plotted on the basis of a 27-day period. Astronomers tell us that the polar regions of the sun rotate once in approximately 34 days, while the equator rotates once in approximately 24 days. Since the magnetic disturbances tend to repeat themselves on the average of every 27 days, it seems probable that the sun spots, or other conditions on the sun, which have the greatest effect on the magnetic conditions on the earth, are located at such a latitude on the sun that the average period of rotation is approximately 27 days.

This is the basis of the prediction service, that is, if we have a magnetic disturbance on a certain day, say November 7th, we would expect this disturbance to appear again 27 days later, or on December 4th, as indicated on the chart for 1933.

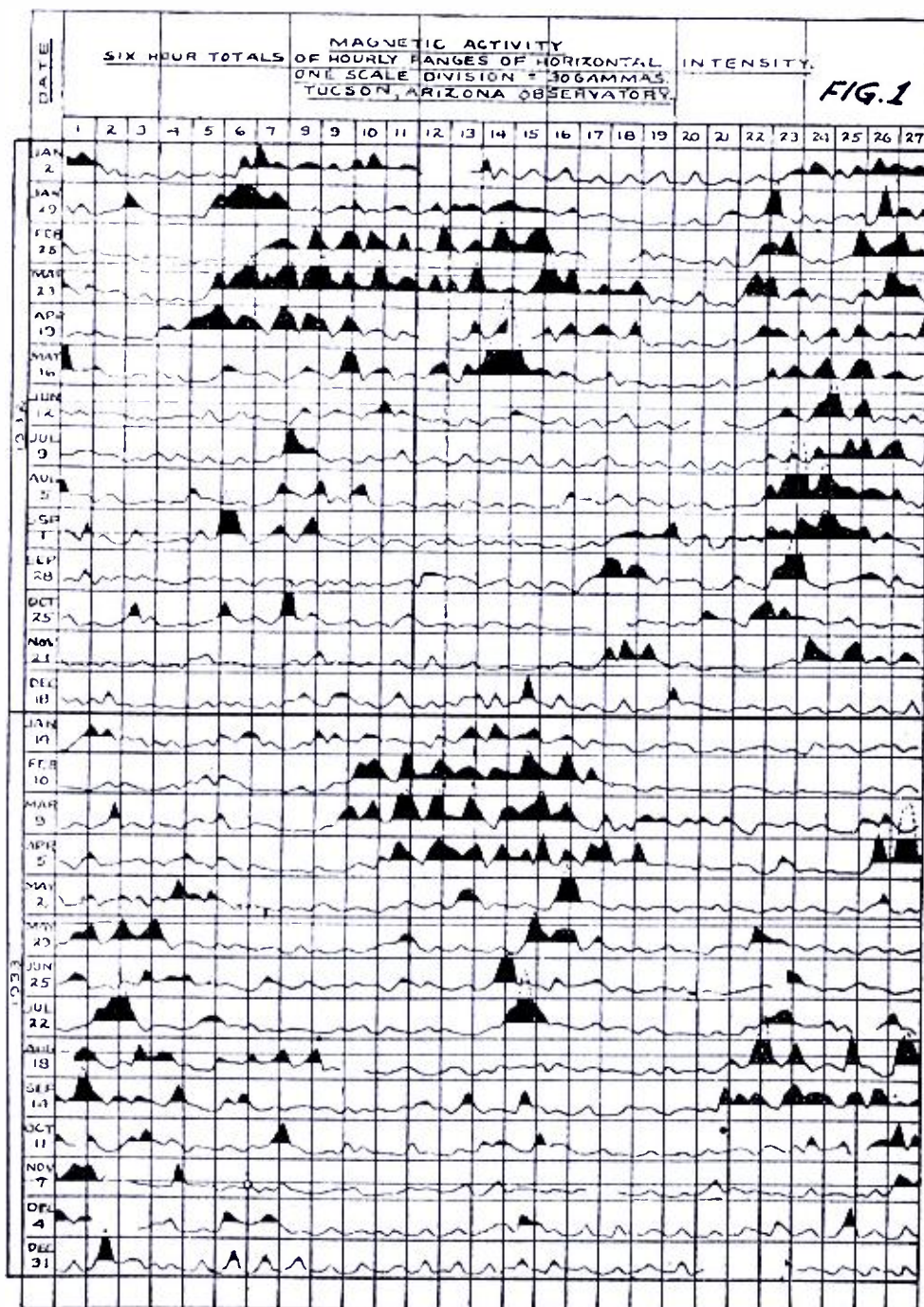

In general, this repetition tends to occur for several cycles, although it is not an invariable rule, particularly if the magnetic storm is a very severe one. For example, on August 5, 1933, an unusually severe magnetic storm occurred, but this disturbance did not repeat 27 days later, although it did appear again 54 days later with much less intensity than on August 5th.

In this case we predicted disturbed conditions on September 1st, but actually found no disturbance. Thus, it is not possible to be sure of the accuracy of the predictions, but, in general, it is possible to predict the times which are subject to disturbance and the times which are reasonably certain to be free from disturbance.

Essential Factors

We have found good co-ordination between subnormal signals and magnetic range, so that wherever a black peak occurs on the chart, the effect has almost invariably been noticeable on signal transmission, especially from Northern Europe. Of course, there are many factors to consider, such as distance, direction, season, time of day, frequency, etc. For example, if a frequency is too low for a given circuit at a certain time of day, a moderate magnetic disturbance might actually increase the intensity of the signal above normal.

An examination of the chart indicates that November, December and January are usually fairly free from magnetic disturbances, and that definite disturbed periods do not tend to build up until February, March, or even later in some years. Until definite groups do build up, it is obvious that the predictions are not likely to be very accurate.

SUMMARY : *An interesting discussion of magnetic storms and how they affect radio reception—especially short-wave reception—is contained in an article in the May, 1934, issue of "Broadcast News," by H. H. Beverage, chief research engineer of RCA Communications, who needs no introduction to students of radio; he originated the antenna system that bears his name.*

From data collected, Mr. Beverage attempts to predict reception conditions, especially for the higher radio frequencies.

Magnetic storms also manifest themselves by relatively large changes in the potential between points on the surface of the earth. This potential is sometimes sufficiently high to seriously disrupt telegraph and cable circuits which use a ground return.

A continuous record of earth potential is useful in the preparation of prediction charts. Figure 2 is a record of earth potential between two points six miles apart near Riverhead, L. I. This record was made on March 24, 1934, and is an interesting example of an unpredicted disturbance. It will be noted that the voltage line was fairly constant until about 6 P.M. Shortly after, a rather violent fluctuation of voltage occurred. The Byrd program from Little America was interrupted by this disturbance until about 10:20 P.M., at which time conditions recovered so rapidly that it was possible to obtain fairly good reception from Little America.

On a day which is magnetically quiet, only a uniform line is recorded.

At the present time, we are co-ordinating these earth potential records with the Tucson magnetograms in order to determine whether a useful relation exists between earth potential and magnetic range.

These predictions are of considerable value for scheduling program service events, or for determining in advance the periods of best reception for short-wave broadcasting stations. The reception of voice and music is relatively sensitive to magnetic disturbances, largely due to the detrimental effects of selective fading. The telegraphic services, on the other hand, are affected to a relatively minor degree, and only the most violent magnetic storms impede the flow of traffic to any substantial extent.

Editorial Note

It will be interesting to note the effect of the new sun-spot cycle on short-wave reception. The period of these cycles is about eleven years, and we are just entering upon a new one. Unfortunately, sufficient data have not been collected on changes in short-wave reception caused by sun spots, although it is hoped that such data will soon be available.

The Kennelly-Heaviside layer will no doubt be affected by the presence of sun spots, and sun spots have a habit of changing the periodicity and intensity of magnetic storms. In this connection, therefore, the data for the next eleven years should be of more than casual interest.

It is interesting to note from Mr. Beverage's report that magnetic storms affect voice and music to a greater extent than telegraph signals.

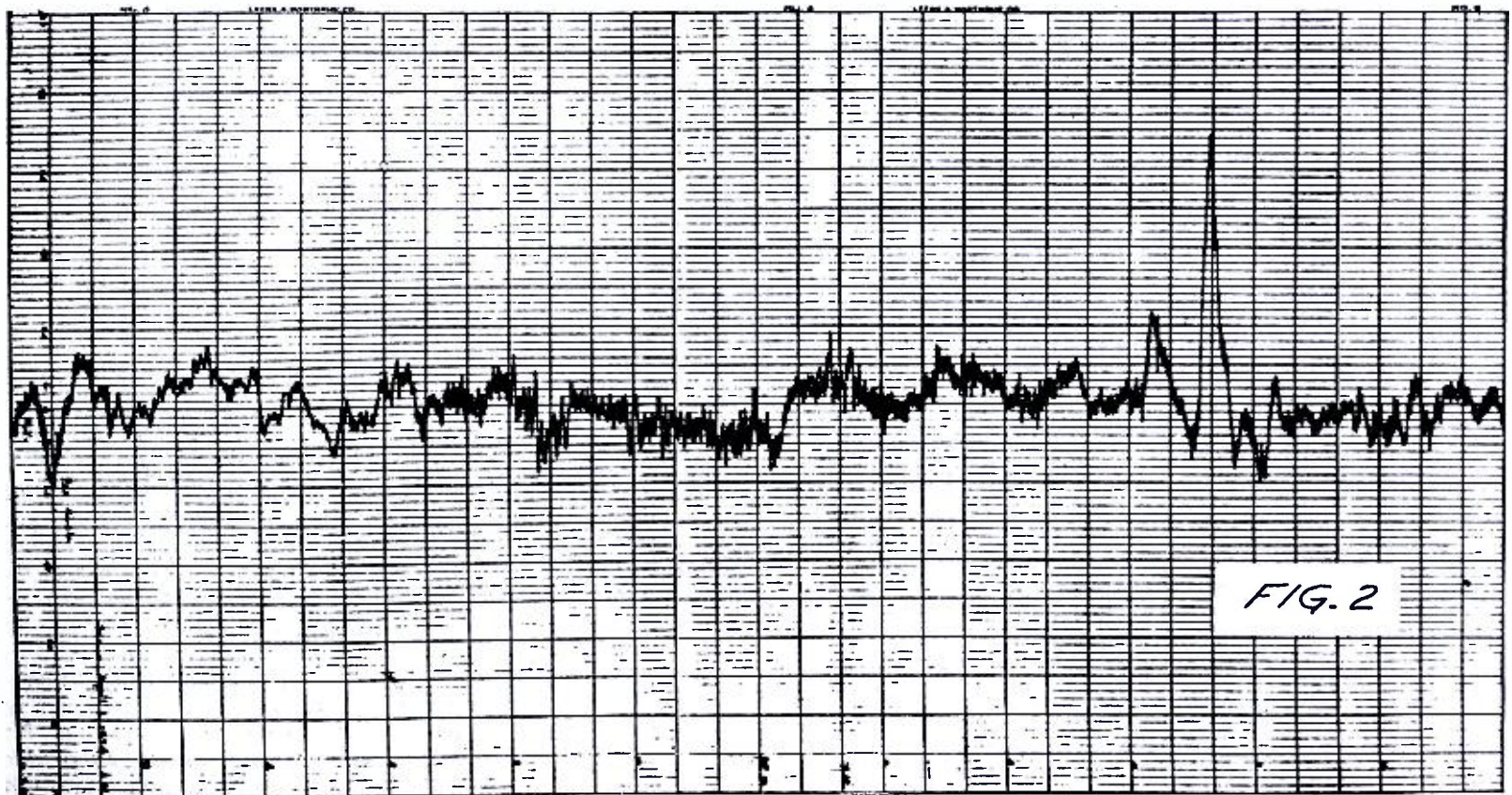

The ordinate represents voltage; the abscissa, time. The time of the disturbance is at the right of the diagram.

Reaction in Radio Receivers

SUMMARY: *Oscillation at high frequencies may be minimized by the proper use of shielding. The theoretical treatment of the subject by Mr. Hurff substantiates in every respect the practical discussion of the subject given by Mr. Kruse in the June issue of this magazine. Reaction due to electrostatic, magnetic, and impedance coupling is discussed.*

By Joseph L. Hurff*

FOR the last several years, the trend of the radio art has been toward receivers having higher and higher radio-frequency gain, or amplification. This tendency has resulted from the desire first, to obtain greater overall gain, and, second, to obtain a greater percent of the overall gain by means of amplification at radio frequencies. High radio-frequency gain, as made practical through the use of tubes which have become available during the last few years, requires the use of extensive shielding to prevent reaction due to undesired coupling. Reaction is the result of coupling which occurs when two circuits are so placed or interconnected that a change of conditions in one circuit reacts on the other due to a transfer of energy. Reaction may result from either electrostatic, magnetic, or impedance coupling at radio frequencies. Unless suitable shields and filters are used in a receiver to prevent reaction due to coupling between parts of circuits which are at different radio-frequency potentials, it is impossible to obtain high amplification, since the receiver would be unstable or break into spurious oscillation.

When a vacuum tube is used to amplify radio-frequency energy, the energy is impressed on the grid of the tube and the amplified energy, perhaps increased many times, appears in the plate circuit. This tube with its associated circuits constitute a stage of radio-frequency amplification. As a result of the amplification which takes place within the tube, a difference of radio frequency potential exists between the grid or input circuit and the plate or output circuit of the tube. For proper operation of an amplifier stage, these circuits must be electrically isolated to prevent reaction due to undesired coupling.

*Radio Dept., Westinghouse Elec. & Mfg. Co., Chicopee Falls, Mass.

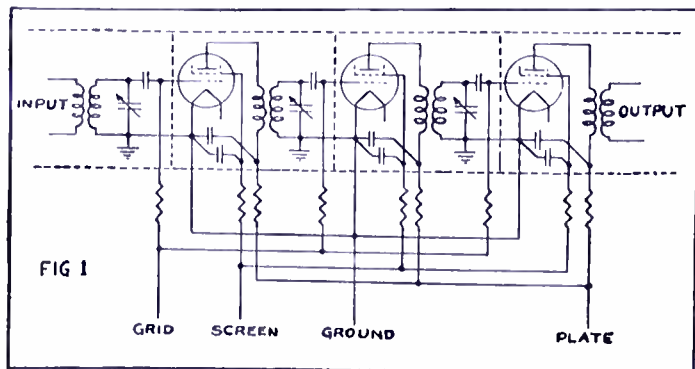

FIG 1

Ordinarily, radio-frequency amplifiers consist of more than one stage, as shown in Fig. 1. Each grid circuit in most amplifiers is fed by some coupling arrangement from the plate of the preceding vacuum tube. The plate circuit of the first tube and the grid circuit of the succeeding tube are at practically the same radio-frequency potential. Likewise, the plate circuit of the second tube and the grid circuit of the third tube are at practically the same radio-frequency potential, and so on. Therefore, the problem of shielding such an amplifier consists of preventing the plate circuit of each tube from coupling to any circuit other than to the grid circuit of the tube immediately following it.

The ideal place to effect the electrical isolation between stages would be inside the tube and between the grid and plate elements. Since this is obviously impossible, the best practical arrangement is to shield the circuits as closely to the tube as possible. The electrical isolation of stages will then be as indicated by the dotted lines in Fig. 1.

Reaction Caused by Electrostatic Coupling

Reaction due to electrostatic coupling exists when one circuit is so placed that an electrostatic field exists between it and another circuit. The flux lines of an electrostatic field extend in relatively straight lines between points having different radio-frequency potentials. The earth, or any large mass, is considered to be at zero potential; and if a grounded or "earthed" metal plate is placed between points to be electrostatically shielded, the flux lines from each of the two points will stop at the grounded plate.

Electrostatic shielding provided

A schematic of a typical radio receiver showing the parts that should be included in every shield compartment. See the text for further details for best isolation between stages.

by a grounded metal plate or screen between vacuum tubes, tuning capacitors, etc., is all that is required to isolate circuits (and circuit elements) when they have negligible inductance. The grid and plate elements within the amplifier tube itself create the first problem. These elements are at different radio-frequency potentials because of the amplification of the tube, and an electrostatic field exists between them. Energy will thus tend to be transferred from one to the other through the internal grid and plate capacity of the tube. In the three-element vacuum tube this radio-frequency coupling must be neutralized. The four-element or screen-grid vacuum tube requires no neutralization, except in special cases, since the screen grid effectively isolates the control grid and plate elements.

Reaction Due to Magnetic Coupling

Reaction due to magnetic coupling exists when one circuit is within the magnetic field of another. Lines of magnetic flux are closed and surround all conductors carrying current. Because the inductance of a straight wire is small, the magnetic flux produced by current flowing in it is usually negligible; but any complete turn of wire has an appreciable amount of inductance and is a source of magnetic flux which must be considered. The tuned circuit coils, made of many turns, produce the greatest amount of flux and must be carefully shielded, usually by tight cans or boxes made of a highly conductive material, such as copper or aluminum.

A shielded coil is analogous to an air-core transformer in which the coil is the primary winding and the shielded can is a short circuited secondary winding. The flux produced by the coil induces an electromotive force in the shield by transformer action, causing a current to flow in the walls of the can approximately opposite in phase to the current in a coil (Lenz's Law), as shown in Fig. 2. The magnetic flux caused by the induced current substantially neutralizes outside the shield the original flux produced by the current in the coil.

If the shield material has a permeability of unity, its presence will not distort the magnetic field of the coil until radio-frequency current

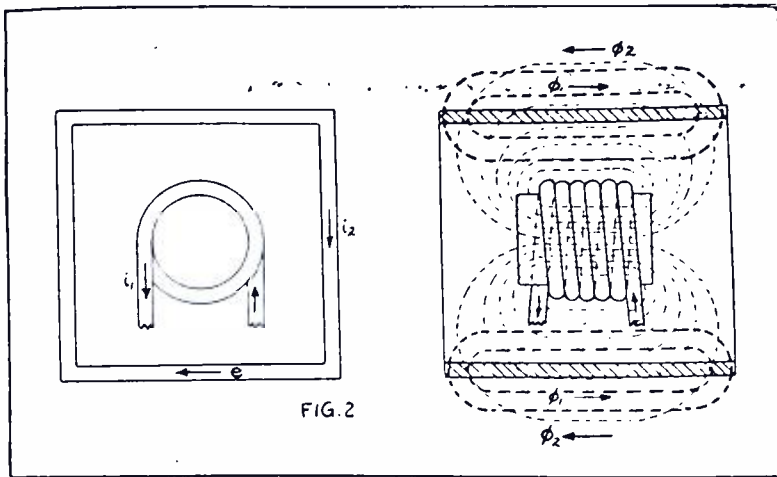

The theory of shielding may be regarded as similar to the action of a transformer with a short-circuited secondary. The flux generated by the secondary (the shield here) at the point where the shield is located just about equals that generated by the coil.

begins to flow in it. The flux density will vary inversely as some function of the square of the distance from the coil, as shown by the curve for ϕ_1 (ϕ_1 is the Greek letter phi), Fig. 3. At some distance, d , from the coil will be located the wall of the shield. When radio-frequency current flows in the shield, it is approximately 180 degrees out of phase with the current in the coil, and its flux will also be approximately 180 degrees out of phase with the flux produced by the current in the coil. Hence, the magnetic field due to the current in the shield is plotted below the axis of abscissas, as represented by ϕ_2 in Fig. 3. The resultant flux field is ϕ_R . The magnetic field ϕ_2 due to the current i_2 in the shield will cancel some of the flux ϕ_1 produced by the current i_1 both inside and outside of the can as shown in Fig. 3. The effect of this cancellation of some of the flux ϕ_1 produced by the current i_1 in the coil is to decrease the apparent inductance of the coil.

Some Conclusions

Several interesting conclusions can be drawn from a consideration of Fig. 3. For the best shielding, the current in the can must be as close as possible to 180 degrees out of phase with the current in the coil for the opposing magnetic fields to reach their maximum value simultaneously. Since the phase relations of the current in the shield depend upon the resistance and reactance of its path in the shield, the best results are obtained when the reactance is large with respect to the resistance. The length of the current path, and accordingly the resistance, increases directly with the diameter of the can and the inductance increases as the square of the diameter. The ratio of reactance to resistance increases with the diameter; hence, the larger the can the more effective a shield it is.

Since the walls of a larger shielding can are in a weaker field, the actual amount of unneutralized coil flux will be less even though it is the same percent of the coil flux at the shielding wall. A large shielding can is also an advantage because the walls are in a weaker magnetic field and the cancelled flux due to the shield current is less, causing

a smaller reduction in the apparent coil inductance.

The resistance of a shield is minimized by using thick walls of highly conductive material, such as copper or aluminum, and welding or soldering all the seams. If a magnetic material such as iron were used, the radio-frequency flux of the coil would concentrate *within the shield* and much of it would have to be neutralized by the flux in the shield created by the shield current. The result would be a great decrease in the coil inductance. The effective resistance of such a shield would be high because of magnetic losses. The phase of the shield current might be altered sufficiently to render the shield ineffective.

Reaction from Impedance Coupling

Reaction due to impedance coupling exists when an element of one circuit is so connected that it is also a part of a second circuit. Any circuit element, even a length of connecting wire, will have some capacitance, inductance and resistance; at radio-frequencies, the impedance of such an element will be appreciable. If this impedance is common to two or more circuits, variations of radio-frequency current in one circuit will cause a difference of radio-frequency potential to exist across the impedance that will effect the second circuit. Reaction produced by undesired impedance coupling may be minimized by the proper use of filters and the proper location of ground connections.

Independent filters should be used in the power supply leads for the various radio-frequency amplifier tubes, as shown in Fig. 1, to remove the radio-frequency current component before it reaches the common power supply and couples with another tube. It is sometimes necessary to provide filters in the filament or cathode circuit in addition. The simplest type of filter consisting of a single resistor (or choke) with a bypass capacitor is usually sufficient. The resistor (or choke) should be placed just outside of the shield and the bypassing capacitor should be connected at the point where the lead passes through the shield.

The ground lead from the bypass capacitor must not be long or common to two or more capacitors. It should connect to a point which completes the radio-frequency circuit; in this case, to the cathode. If the bypass capacitors are grounded to the nearest point on the chassis, the bypassed radio-frequency current will flow through the shield to complete the circuit and couple to other circuits near or connected to the chassis, and this will produce reaction.

(An interesting discussion of methods of measuring the effectiveness of shielding is contained in the third edition of Morecroft's *Principles of Radio Communication*. Briefly, the method consists of measuring the voltage induced in a second coil by the coil to be shielded. Measurements of this voltage before and after shielding is an indication of the efficiency of shielding.)

Perhaps many readers will recall the so-called "doughnut" coils, so popular during the broadcast construction boom. These coils, technically known as toroids, have no external magnetic field—theoretically. Therefore, they require—again theoretically—no shielding. It might be well for some enterprising manufacturer to try and construct some short-wave toroids.

Another attempt to minimize the amount of necessary shielding manifests itself in the more or less general use of lattice-wound, compact coils.—*Tech. Dir.*

A chart illustrating the extent to which the coil flux is cancelled by the shield flux. Note that grounding of the shield is not essential for cancellation, although it maintains the electrostatic potential of the shield at a constant value, which aids the overall shielding effect.

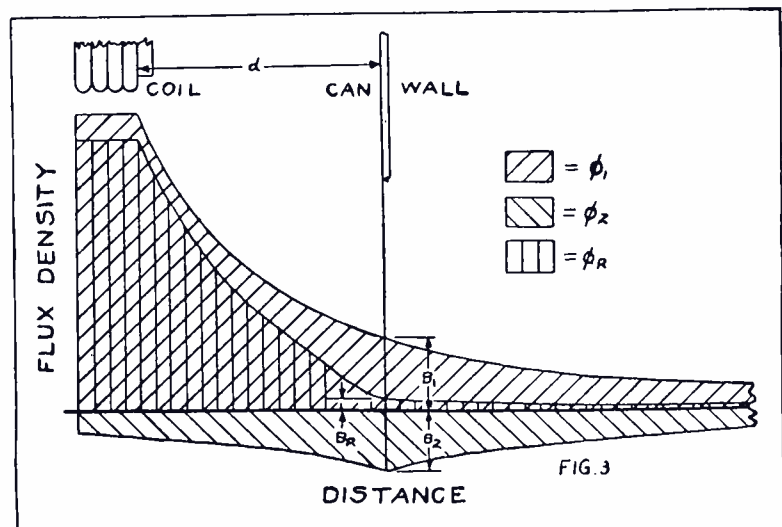

Common and Uncommon Uses of Regeneration

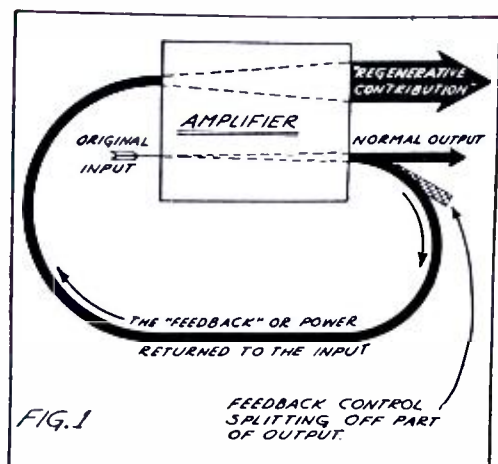

FIG. 1
FEEDBACK CONTROL
SPLITTING OFF PART
OF OUTPUT.

An attempt to picture regenerative action. The black wedge is intended to represent a device for splitting off more or less of the a.c. output for feed back to the input. In this crude picture control of regeneration would be effected by moving the edge of this wedge to shave off more or less of the stream.

PLEASE settle back and endure a brief review which may lead us to some very useful conclusions. Regeneration is possible where—and only where—there is amplification. It is *not* solely a radio-frequency effect; we can also have intermediate-frequency regeneration, audio regeneration and d.c. regeneration. Figure 1 explains in a general way what goes on, and why a precise control is needed to get anything like the ideal effect.

At this place I'd like to work in a term that we will need further on. Several contradictory ways of studying regeneration have been invented. For example, one hears regeneration described as "equivalent to the introduction of negative resistance into the input circuit!" "Negative resistance" is an idea about the same as that of describing hunger as a "negative dinner." It's a clumsy way to say that regeneration reduces the resistance of the tuned circuit (or whatever it is) which feeds the amplifier. Trying to imagine such a result gives us no very clear picture, and does not account very well for the trick type of selectivity which we obtain with regeneration.

Regeneration a Reamplification

A simpler way of thinking of the phenomenon is to imagine that the signal went through the amplifier once, and then a part was sent through again to be re-amplified. Thus we have added a sort of ghostly amplifier, one that isn't there until we regenerate. If this ghostly amplifier contributes anything, we can call it a "regenerative contribution." This term I believe we owe to Stuart Pallantine, although I doubt if he would endorse this inexact discussion.

Not all amplifiers use vacuum tubes, although we sometimes forget those that don't. If we use vacuum tubes, they usually have one, two or three grids, and the output is gen-

* Consulting Engineer.

SUMMARY: This article by Mr. Kruse is one of the most interesting resumés of some common and uncommon uses of regeneration that we have had the pleasure of reading in a long time. Regeneration in the control-, screen-, or suppressor-grid circuit is discussed, as is regeneration in the conventional plate circuit. R.F., i.f. and audio regeneration are discussed, and complete circuits for their use are given for constructors.

By Robert S. Kruse*

erally taken from a plate. It simplifies things very greatly if we can manage to remember that *any of the grids can be used to control the plate current*; therefore, we can "feed back to" (regenerate into) *any* grid in the tube. From this it follows that the principle isn't changed when we use "grid regeneration," "screen regeneration," or "suppressor regeneration." They are all grids. Name me some more breeds of grids and we will extend the statement to

them too. We can even feed back from a high-voltage grid to a low-voltage grid. See B1 and B2 of Fig. 2.

More than that, we can work up dozens and dozens of combinations of ways of doing the thing. We can feed back to one grid and control the feed-back by varying a d.c. voltage, an r.f. bypass or the feedback coupling either on that particular grid, on some other grid, or on the plate. Figure 2 shows a few schemes; there are lots and lots and lots of others, somebody "invents" one every few days—but they *all use the same old principle*.

With so many ways of doing a thing, how shall we choose the "best one"? As you may have guessed, there is no "best way"; in fact, perfectly honest and careful experimenters do not obtain test-results which agree. Why should they? After 25 years automobile designers do not agree very well on engine types, methods of braking, springing and snubbing; but all the cars work, and every type is a favorite with some owner. Now let's get down to specific cases and purposes.

A Simple Example

The simplest case, in some ways, is the detector-audio receiver of Fig. 3A. The input is a radio signal direct from antenna or via an r.f. amplifier, and the output wanted is simple audio to be fed to the audio amplifier. If we are receiving a phone signal, we shall use a moderate amount of regeneration for the purpose of improving the very low gain and selectivity of such a receiver. Here we meet the first problem: to stay in the region B of Fig. 3B without getting into region C or D. Note here the important point that, *no matter what sort of regeneration control be used, a slight change will produce a great change in "regenerative contribution"* in region B.

Now, one of the changes which could happen inside the tube would be for the grid to move a little because of vibration. That this is really important is shown by the fact that a detector becomes very microphonic when we are well up in

Things to Remember about Regeneration

- 1—The regeneration control requires a reduction drive like that of the tuning condenser—though few sets have it.
- 2—Triodes, tetrodes and pentodes may all be used regeneratively. Smoothest control is obtained with a tube of high mutual conductance; thus, the 112 triode with a mutual of 1800 handles more nicely at short waves than the old triodes (mutual 800), the 24A tetrode (mutual 1000 for same voltage) or the 39/44 r.f. pentode (mutual 1000 at the same voltage).
- 3—Any rheostat or potentiometer used for r.f. control, especially if carrying d.c., should be equipped with a light, firm contact traveling directly on a smooth resistor element. Wire-wound resistors are not suitable. Opinion differs as to compression types.
- 4—A regenerative stage (r.f., i.f. or audio) becomes more selective to weak signals, but more subject to overloading (cross modulation or blocking) on strong signals. The last tendency is much less if the tube is oscillating strongly.
- 5—If a tube is noisy (at the speaker or headset) when tapped, it is almost certain that regeneration is present, intentionally or by accident. This is a common laboratory test for deficient shielding and r.f. de-coupling. No such effect should be met with the regeneration control "cut back."
- 6—Detector regeneration in modulated reception can give gains of 10 to 100 in ordinary practice, providing no associated amplifier is thereby made unstable and the detector itself is not overloaded as a result of regeneration.

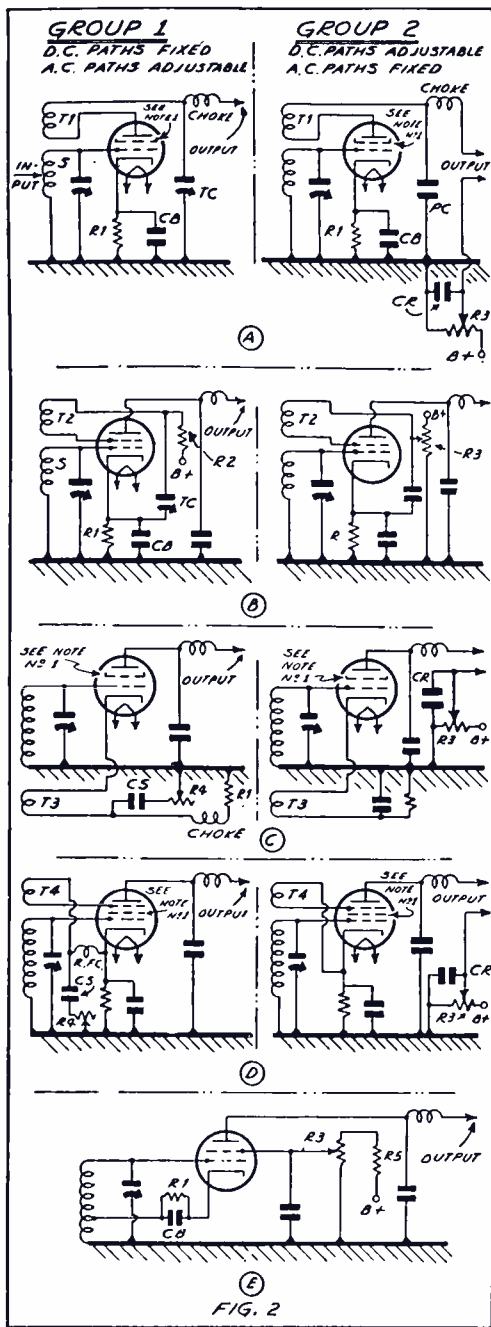

A few of the many practical ways in which regeneration can be controlled. C batteries or gridleaks leave the principle unchanged, though in the C1 circuit the combination of C5 and R4 would then be shunted across T3.

Note 1—In the A, C and D circuits the screen connections are normal and were omitted for simplicity. In circuits A2, C2 and D2 the control can equally well be effected by varying the screen voltage (as in B2), the plate voltage being fixed. Note 2—Constants: T1—Number of turns depends on number of turns in S. At 500 meters, T1 has 5-10% as many turns as S, increasing until at 5 meters it has 150% the turns of S. T2, twice as many turns as would be needed for T1. T3, about 1½ times as many turns as needed for T1. T4, same as T3. TC, "throttle condenser" for controlling regeneration, capacity (maximum) 2 mmf. for each meter of wavelength—for instance, .0002 mf. for 100 meters. CS, twice the correct value for TC. P.C., same as TC at maximum—or as much as 50% larger. CR is a noise-absorber, capacity between .1 and .5 mf. CB, the usual bypass for R1, the usual cathode resistor. R3, 50,000 ohms NOT wire-wound or having wire contacts. Must be smooth. R4, tapered 5000 ohm volume control type. R5, 20,000 ohms.

Note 3—Circuit E is a Dow oscillator, having the (sometimes important) advantage that the screen is at the same r.f. voltage as chassis. The tap in E is about 10% of the way up the coil.

region B. This is one of the weaknesses of the regenerative detector; therefore, the theoretical possibility of immense gain can't ordinarily be attained, although "regenerative contributions" of 10 (voltage gain) are easy, and 100 may be had with luck. "Luck" here means that nothing bumps the tube hard enough (electrically or mechanically speaking) to push it into region C. We have mentioned mechanical bumps, and protection against them is simple. Electrical bumps may consist of static, strong signal interference, fading of the wanted signal, changes of supply voltage (especially in an a.c. receiver), irregularities in the workings of any variable resistors, or unsteady operation of the tube itself. If all these could be dodged, we could gain any regenerative contribution desired. Carefully protected battery-driven regenerative detectors have been made in a laboratory to give gains vastly higher than those named above.

Selectivity

Now as to selectivity. Here we get a result that at first seems curious. It is represented in Fig. 3C. Observe that the "regenerative selectivity" curve has a queer shape, being very sharp right on the tune, but broad as all outdoors at the base. The practical meaning of this is that the circuit is highly selective to weak signals, and helpless against strong interference. Such a curve might be anticipated by considering that the sharp, thin horn is put there by regeneration, which is working only at the "on tune" frequency. If we had actually lowered the tuned-circuit resistance, the curve would look more like the dotted one. Of course, the "negative resistance" folks get out of this by explaining that their particular brand of negative resistance exists only at the "on tune" frequency. This is at least ingenious; but one can find fault with my "ghostly amplifier," so we are even.

To give you some idea of the "regenerative contribution" to be expected in this sort of set, an a.c. operated receiver with one r.f. stage, regenerative detector, and two audio stages was found to give a non-regenerative sensitivity of 5000 microvolts. With just enough regeneration to put a barely noticeable "edge" on a 400 cycle modulated signal, this became 100 microvolts—a gain of 50. Fig. 3C shows the corresponding selectivity curves, which are nothing to make a broadcast listener or a phone man happy.

Tuned Antennas

Tuned antennas have nothing whatever to do with this discussion, but they are very important in curing just such a bad situation as we have just encountered. Arbitrarily attacking the 6000 kc. international broadcast band, we find that we can

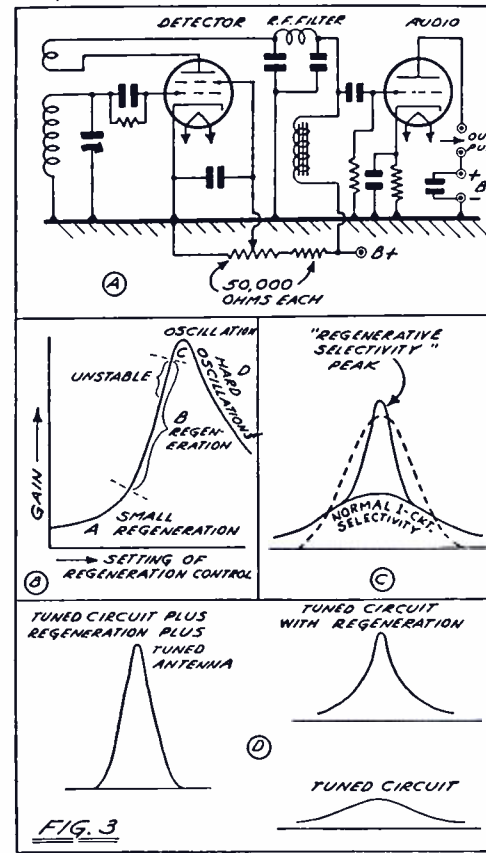

The same old detector-audio receiver.

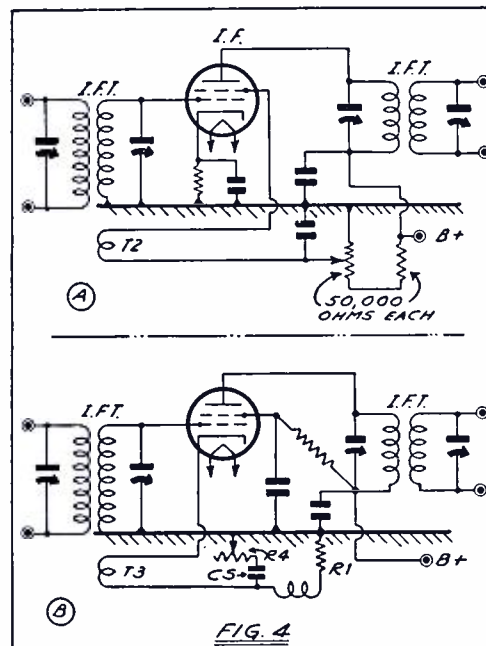

Schemes for sharpening up the i.f. amplifier. See Fig. 2 for constants. Circuit A is somewhat quieter than B in my experience, but the tickler turns must be changed when the tube is changed—unless you have luck.

get the effect of Fig. 3D, which is good enough to amount to something, even today. The noise goes down, too. In this particular case, the antenna was a one-wire affair having a length (lead-in and antenna) of 100 feet; hence, a natural wave around 120 meters, and not much good at 50 meters—which is 6000 kc. It was accordingly loaded up to the 160 meter amateur band by means of a .00035 mf. condenser (variable) and an assortment of coils. This was done by listening. Then the handiest of the coils was put within about two inches of the receiver, set into oscillation, and tuned to the 6000 kc. band. A little hunting produced W8XAL, and then

turning of the .00035-mf. antenna condenser brought them from a whisper to booming volume—showing that the antenna was now tuned to 150 meters. The former interference from a nearby broadcast station and a still-nearer-by telegraphic station had disappeared; the signals were very much better, and, as far as the 6000 kc. band was concerned, nothing new had to be adjusted.

C.W. Reception

Although detector-audio receivers are easily used for c.w. reception by simply throwing them into oscillation—region C of Fig. 3B—the requirements are different. For one thing, the sensitivity is of a different sort, responding more uniformly to weak and strong signals—a sort of automatic volume control effect. For another thing, we need not worry about selectivity to the same extent since a slight change of tuning sends the note rapidly up or down until it falls outside the response-range of the audio amplifier and our ears. Not—mind you—that this is enough to receive through the horrible pandemonium of the 40-meter amateur band.

For i.f. regeneration, one requires a very selective superheterodyne or a special sort of receiver lately devised and perhaps to be described here at another time. When one refers to highly selective superheterodynes for c.w., the intention is to speak of a thing much more selective than any broadcast receiver can dare to be—so sharp that it would skin off most of the music and leave the half-naked carrier-wave.

One way of doing this is to use the Robinson stenode, merely leaving off the audio-correction device which Robinson used to bring up the “cut down” sidebands. Of course, a second, or beat-note, oscillator is needed, but that is a common need for any superheterodyne used for the c.w. reception.

Such a cut-down stenode has been popularized by *QST* magazine under the name of “single signal,” because the Robinson crystal-filter in the i.f. amplifier can be made so sharp that usually only one signal at a time is heard, even in a jammed c.w. amateur band.

I.F. Regeneration

Another way of going at the thing is to use i.f. regeneration so as to produce the sharp “horn” as was shown in 3C, except that we are dealing with intermediate frequencies. The diagrams of Fig. 4 show how such regeneration can be applied to i.f. amplifiers. This arrangement will be less sharp than a stenode, but much sharper than a non-regenerative super. It will also be noisier than a stenode, but I cannot prophecy whether it will be more or less noisy than it was before you regenerated—that result depends on many circuit considerations and even on the

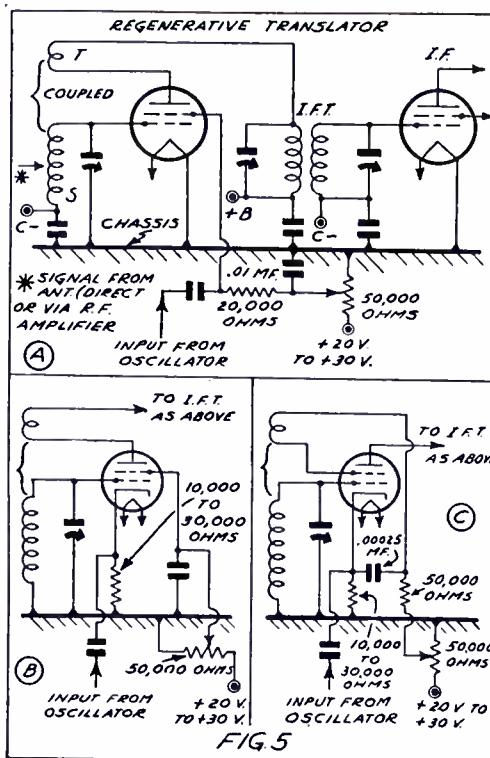

Typical circuits for use in receivers having regenerative first-detectors. See Fig. 2 for additional circuit arrangements.

tubes used in the i.f. This isn't theory, but experience. The newly-modified receiver will ordinarily be more subject to strong-signal interference if adding i.f. regeneration increased the noise. If you can locate the cause of the noise, you will frequently cure the latter also. In some cases we find that additional bypassing of cathodes, screens or filaments to chassis with non-inductive condensers of about .1 microfarad capacity is curative or beneficial.

The “cussed” feature of such an i.f. regeneration scheme is that the i.f. amplifier changes both its selectivity (which we wanted) and its amplification (which we didn't). Therefore the regeneration control is also a gain control, and we have two of these things to juggle. This isn't bad if one is willing to set the regeneration control and then leave it alone.

Another bad feature is that, if the set uses only one i.f. stage, you may find the first detector tending to oscillate whenever the i.f. is made regenerative. If the set has fair shielding and a fairly high i.f., this can be cured in most sets by improving the r.f. filter between the first detector and the first i.f. tube. However, if you attempt to receive c.w. in the 150-175 meter region with a regenerative i.f. system having a resonant frequency in the region of 1500 kc., various silly effects will result, including motor boating, canary-bird effects and imitations of a hen that's just laid an egg. Here we have one case where a 1575 kc. i.f. does not fit into amateur practice very well.

The effects just mentioned were occasioned by the use of an i.f. which was chosen to place “repeat points” far apart so that receivers with only one tuned circuit between antenna and detector would operate reason-

ably decently. Unless one is interested in c.w. reception as just described, this is still a wise choice—much better than the 445, 450, 480 and 500 kc. systems which are (except in a stenode) only a compromise intended to allow a set to be used at both short and long waves; for long waves alone, 175 kc. is still to be preferred, in my estimation.

Having a 1575-kc. i.f. system—with “repeat points” 3,150,000 cycles apart—we do not need any very terrific selectivity between antenna and first detector, provided we can prevent the occurrence of outright cross-modulation. For many locations, it is quite O.K. to use one tuned circuit working into a regenerative 1st detector, which may be of the bias type, using a variable-mu tetrode or r.f. pentode. Suitable circuits, due to L. W. Hatry, are shown in Fig. 5. These are circuits which Mr. Hatry has used in many sets.

“Super” Regeneration

When a detector is run into the C region of Fig. 3C, it does not get there instantly, although the journey does not take long. It slides up through the B region and goes into oscillation; and, while passing through the “unstable” region of B, we have very great amplification, though we can't make the tube stay there. Some years ago E. H. Armstrong devised a scheme for using this effect. Since it wasn't practical to keep jiggling the regeneration knob back and forth fast enough, he got the same effect by changing the grid bias of the detector very rapidly by applying a high-pitched alternating current to it, killing and starting the oscillations at each a.c. cycle, and therefore flipping hastily through the “unstable” region once each cycle.

The amplification is very high, but there are numerous serious defects: the tuning is very broad and the set is oscillating so hard as to be a fair transmitter of low power. Abandoned at normal broadcast bands, these receivers have been, in the last few months, used at 5 meters and thereabouts, for the curious reason that their broad tuning suited them to receiving the “wobulated” transmitters which have been current in that band—in fact, made them produce better signals than would a selective receiver with the same sort of signal to work on. As transmitters improve, this reason for the use of “super-regen” receivers will be weaker.

Mixer-Oscillator

There have been many broadcast receivers in which the translator or “mixer” was also the oscillator, by reason of having two separate tuned circuits connected to it. Since these must “track” with a constant separation equal to the intermediate frequency, their application to multi-band operation has been rather recent. Often enough, the thing is

being done with rather complicated tubes like the "pentagrid" 2A7, 6A7 and so on. (See my own recent discussion in these pages of the General Electric K-80 receiver, April, 1934 issue.)

Now, at 5 meters we can escape these complications and use a very simple oscillating triode translator with one tuned circuit. The reason is that at 5 meters we are dealing with a frequency of 60,000,000 cycles; therefore, we need to go off the tune of the signal by less than 1% in order to get a 500 kc. beat, suited to a 500 kc. intermediate frequency system. This corresponds to mistuning by 1 channel in the broadcast band, and you will recall that in the days of one tunable circuit that was hardly a noticeable amount as far as signals went. However, I do not recommend that much mistuning. I recommend a lower i.f., not over 175 kc. at most—preferably something between there and 40 kc. Then the mistuning becomes inconsiderable and such 5 meter supers have for years given a good account of themselves. I have one battered set made in 1927 which still works very well after being carried through 20 states and after having made some 200 short and long field-exploration trips. See Fig. 6.

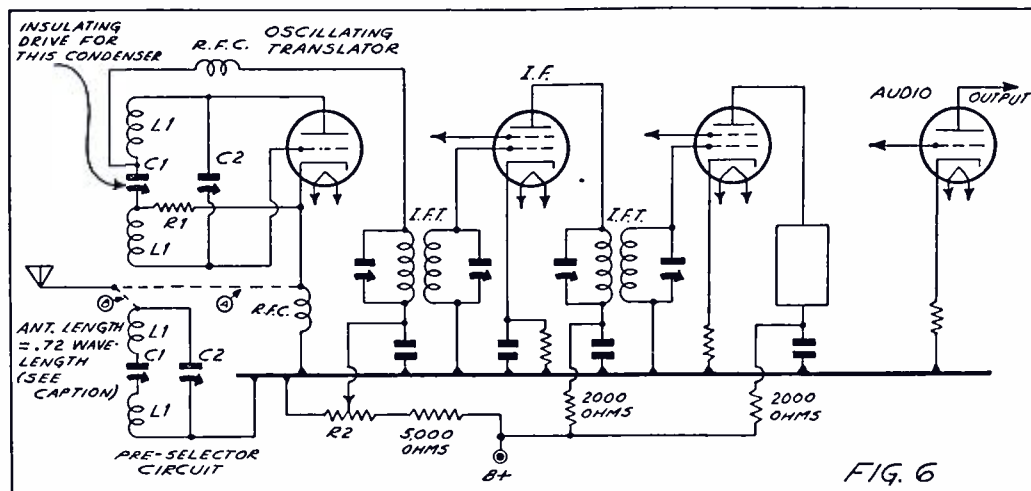

An autodyne superheterodyne circuit for use at 5 meters for voice reception. The screen-connections are normal, hence omitted. For c.w. a 2nd oscillator is needed or one can oscillate the 2nd detector—not a good scheme with the i.f. recommended. The tuned coils may each have 4 turns $\frac{3}{4}$ " in diameter, split for the variable condenser C1, which has a capacity of about .00005 mf. max. C2 is a trimmer set rather wide open—set so C1 covers the desired range. The i.f. should be between 40 and 200 kc. The r.f. chokes should be of a sort good at 5 meters and NOT good at i.f. R1 about 1 meg., R2 about 50,000. The antenna may be connected to the detector grid through a very small capacity, but oscillation control may follow. If antenna A is used, the antenna may be of nearly any length, for the B connection it should be roughly .72 of one wavelength, plus any desired number of wavelengths, of wire. Because the frequency is so high at 5 meters, it is possible to have two separately tuned circuits having their resonant frequencies differing by an amount equal to the i.f. Hence, a low i.f. means that the circuits do not have to be detuned to a great extent. The blank rectangle in the plate circuit of the third tube merely represents any sort of coupling device between the second detector and audio stages.

Dansville, New York, Listener Has Exceptional Foreign Log

Editor, SHORT WAVE RADIO:

Being a one hundred per cent short-wave DX'er myself, naturally your short-wave station department interests me very much; it sure is a fine feature of your magazine. I wish Mr. Hinds the very best of success as the head of this department. His first article in the July issue was fine.

This is my fourth year tuning on the short waves, and have a log of 2210 stations, both phone and broadcast, from 15 to 550 meters. I do not read code but expect to shortly. Am a member of the Heard All Continents Club of the I. S. W. C. and have about five hundred cards and letters from all over the world. Receivers are: National, Hammarlund, Lincoln and Philco. Aerial, cage type 60 feet long.

A station on 30.52 meters which has been a mystery to many short-wave fans is IRW, Rome, Italy. This station rebroadcasts the programs of I2RO, Rome, irregularly in the afternoon; received fine here. RNE, Moscow, 25 meters, with a good signal, may be heard in the East at 8:30 to 10 A.M. E.S.T. They test with New York and also play music. S. W. L.'s sending for verifications to Russia should address their letters, "U. S. S. R." and not "Russia"; otherwise their letters will not pass.

Telephone stations will not verify when testing with other telephone stations as it is considered private business. However, at times these stations broadcast music, and at such times will verify.

Some Station Notes

PDV, Kootwijk, Holland, is now broadcasting music and songs on 24.88 meters irregularly in the afternoons; received here with good signals.

YVQ, Maracay, Venezuela, 22.48 meters, comes in here like a local. They broadcast very good music at times. They verify very nicely when heard with music.

The best Daventry (England) station heard here at present is GSD, 25.53 meters. Their signals are very strong 6 to 8 P.M., E.S.T. DJA, Germany, 31.38 meters, good signals in the evening. DJB, Germany, 19.73 meters, comes in very good in the morning and will improve during the summer.

A fine verification card is sent out by PRA3, Brazil. This station uses the telephone station PSK on 36.65 meters to rebroadcast their programs on short waves, 6 to 7 P.M. E.S.T. GBS, Rugby, England, 24.68 meters, may be heard often on Sundays broadcasting speeches by famous people. They have a wonderful signal.

EAQ, Madrid, Spain, 30 meters, has about the strongest signal of any short-wave station, but their tone is very poor and spoils their programs. A nice verification card is sent out by station LR4, Argentina, Argentina, which uses the transmitter of LSX on 28.98 meters for their broadcasts; irregular in the evenings, signals very good.

Another station which is received

here in fine shape is IAC, Pisa, Italy, 23.45 meters. They work ships, and use the expression, "Pronto-Pronto-Pronto."

To short wave listeners with a high-class receiver, the 20-meter amateur band at present offers some fine DX, and one does not have to read the code either. I shall list some heard on voice here: G5BY, G5BJ, G5CV, G5ML, G5YD, G2GF, G2AX, G201, G2SD, G6WY, G6CW, G6XA, G6DL, all in England. Then there is OA4B, Lima, Peru. This amateur has a trained rooster who crows into the mike. ON4ACE, ON4BZ, ON4AU, Belgium, the latter one plays music. HC1FG, Ecuador, is very powerful and likewise may be heard with some very good music. LU8DR, LU1PB, Argentina; PY1CH, PY2BN, PY2AK, Brazil; HI1G, HI8X, Dominican Republic; CT1GU, CT1BY, Portugal; X1Q, X1M, X1BR, Mexico. Any one with a good receiver should be able to tune in most of these.

Another fine 20-meter station is XIG, Mexico City. Dr. Hard, the owner, is known all over the U.S.A. A lot of radio announcers could take a few lessons from him. It sure is a treat to hear him talk. LA1G, Oslo, Norway, is a fine catch on 20 m. These fellows all speak very good English. To the S.W.L. who wants to increase his DX the 20-meter band will sure do the trick.

Sincerely yours,
Clarence Sargent,
18 Clinton St.,
Dansville, New York.

A Transportable Set for the Car

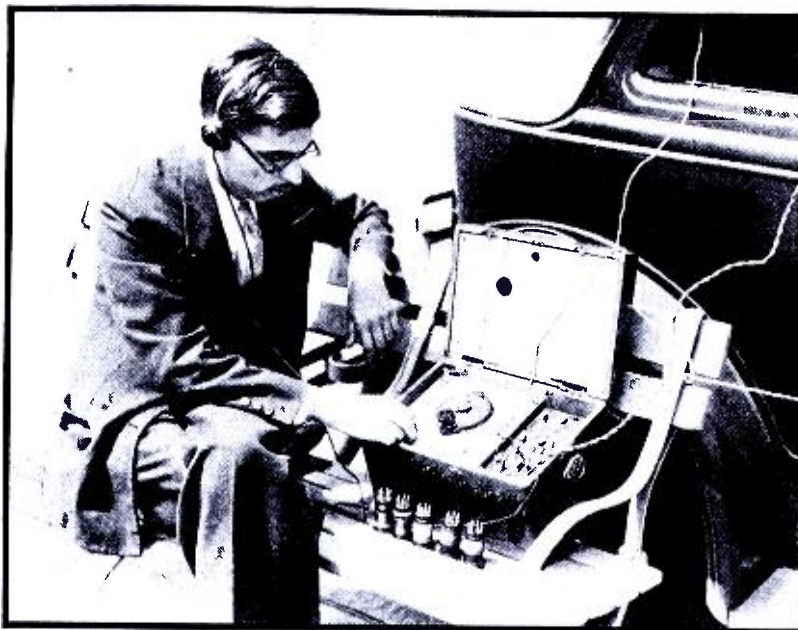

The transportable in operation on the roadside. Note the B batteries in the right hand section of the box.

WITH summer well under way, the thoughts of many short-wave fans are turning toward portable or transportable receivers that they can take with them on vacation trips or automobile tours. Sets of this kind can be a source of considerable enjoyment. Not only do they yield actual musical entertainment along the road or at summer resorts, but they also allow the DX enthusiast to indulge in some fancy "fishing" in locations other than his own home. It really is extremely interesting to take a portable or transportable receiver on a long trip and to try it in different places. Some locations are pretty rotten, but others are really extraordinarily good. A man whose home location is only mediocre and who hears only a moderate amount of DX can frequently take a portable set out into the country, sling an aerial into a tree, and then log dozens of stations that heretofore have existed for him only in call books.

Portable receivers are of two general classes: first, those that are really portable in the sense that they contain their own batteries and can be carried comfortably more than ten feet without dislocating the owner's shoulder; second, those that depend on the storage battery of an automobile for filament supply and contain only their own B batteries in addition to the receiver proper.

Receivers of the first class must be constructed and carried like any other piece of hand luggage, and, of course, the overall weight must be kept at an absolute minimum. The tubes must be of the two-volt series, as these are the only ones whose filaments operate satisfactorily on dry cells. Receivers of the second class are really not portables in the sense that they are carried, but rather should be called "transportables," because they are always

transported in an automobile and are rarely taken more than a few feet from a car. The storage battery of the car is a reliable source of power and permits the use of the extremely rugged and versatile 6.3-volt series of tubes.

To see what could be done along the lines of a transportable automobile receiver, we experimented with a number of different tube combinations and circuits in a variety of containers. The conclusions we have come to are that the box or case is the most important part of a transportable receiver and that the receiver itself must be built to fit it. Of course, if the experimenter is a good cabinetmaker and has complete woodworking facilities available, he can make a box to suit his own fancy, but most of us do not have these facilities and would rather spend our time playing with circuits than building boxes.

Wooden Case Best

As a general rule, a wooden case is better than a metal one for a transportable receiver for summer use. Wood, of course, is a much better thermal insulator than any metal, and this protects the "B" batteries from summer heat. Also, wood cabinets dent much less easily than metal ones. Protection of the B batteries is very important, as only small batteries are practicable for portable use and no B batteries last very long if they are kept in a hot box.

Metal tool boxes immediately suggest themselves for portable receivers, as these are available in a large variety of sizes and shapes. Many short-wave experimenters use cases of this kind, but our recommendation is that you use a wooden box if you can obtain a suitable one.

The stores that sell surplus Army and Navy equipment are the best sources of cabinets for portable re-

ceivers. During the World War both the Army and the Navy bought huge quantities of boxes of many different shapes and sizes for many different purposes. These are now available at very low prices. The old DeForest Company made a number of portable radio outfits for the Army, using crystal detectors for receiving and spark coils for transmitting. The cases for these sets lend themselves beautifully for short-wave use. Similar cases for chronometers, compasses, surveying instruments, etc., still exist by the thousand.

A casual visit to an Army and Navy store on Chambers Street, New York, produced the box shown in the illustrations. This is known as a sailor's ditty box, and, because of its construction, is absolutely ideal for short-wave use. The salesman in the store said that the country is flooded with the things. This ditty box, when closed, measures 14" long, 10" wide and 9" high. It is fitted with a pair of strong handles and is made of hard 7/16" wood with dovetailed corners. The cover by itself is a compartment 1½" deep, fitted with a hinged front of its own. This compartment proved perfect for holding a roll of aerial wire and a pair of Trimm phones, as shown in one of the illustrations. The usable space inside the box measured 13" x 9" x 6⅝".

As we had had previous experience with portable receivers, we first selected three B batteries to fit one end of the box and constructed a receiver chassis to occupy the remainder of the space. The model V-30-B General B batteries proved to be just right, as they measured just a little under 6" high and three together in a row came to 7¾". As these batteries are 4¼" wide, this left a comfortable space of 8¾" x 9" x 6⅝" for the receiver. Accordingly, a panel measuring 8½" wide by 9" high was cut out of Electroly

and a sub-panel 5½" deep was fastened to its back by means of a couple of extremely strong brackets made of ¼" square brass rod. In order to allow room for switches and other accessories on the underside of this sub-panel and coils and tubes in the upper side, this sub-panel was mounted 4" above the bottom edge of the panel.

The first circuit that was tried consisted of a tuned r.f. stage with a 6D6, a regenerative detector using the pentode section of the 6F7, a first audio stage using the triode section of the same 6F7 and an audio output stage using a 38. A double tuning condenser and two plug-in coils comprised the tuning elements. The three tubes fitted comfortably on the chassis and the whole set looked very neat. However, the results were not so good. Interlocking and coupling between the detector and r.f. stages was so bad that the r.f. tube could be thrown into oscillation by bringing the two tuned circuits into resonance with the aid of an antenna trimmer. Furthermore, the regenerative action of the pentode 6F7 was somewhat ragged.

The Final Circuit

In the second attempt, the 6F7 was replaced by a straight 6C6 pentode detector feeding directly into a 38 output tube. While the 6C6 detector by itself operated very smoothly, the interlocking effects still remained. As it was impossible to provide enough shielding in the limited amount of space to overcome this effect, we decided to drop the tuned stage altogether, making the r.f. stage untuned, with the simple choke input as shown in the schematic diagram. This move simplified the coil problem. Where eight coils were previously necessary to cover the short-wave channels from 15 to 200 meters, only four coils are now needed.

With the previous double tuning condenser cut down to a single unit, more space became available on the chassis and the set finally reduced itself to a four-tube combination: 6D6 untuned r.f. amplifier, 6C6 regenerative detector, 37 first audio and 38 output audio. This is a very reliable and smoothly working combination. While the selectivity, of course, is not nearly as good as that of a double-tuned arrangement, the set has the more important virtues of simplicity and reliability, both important requirements in a transportable receiver.

In the completed model illustrated, the single tuning condenser is mounted in the center of the panel and is controlled by a variable ratio vernier dial. Immediately to its left is the 6D6 r.f. amplifier tube. In the left rear corner of the sub-panel is the plug-in coil receptacle and immediately to its right is the 6C6 detector tube with its associated grid condenser and leak. The leak is mounted in a clip mounting, supported up-

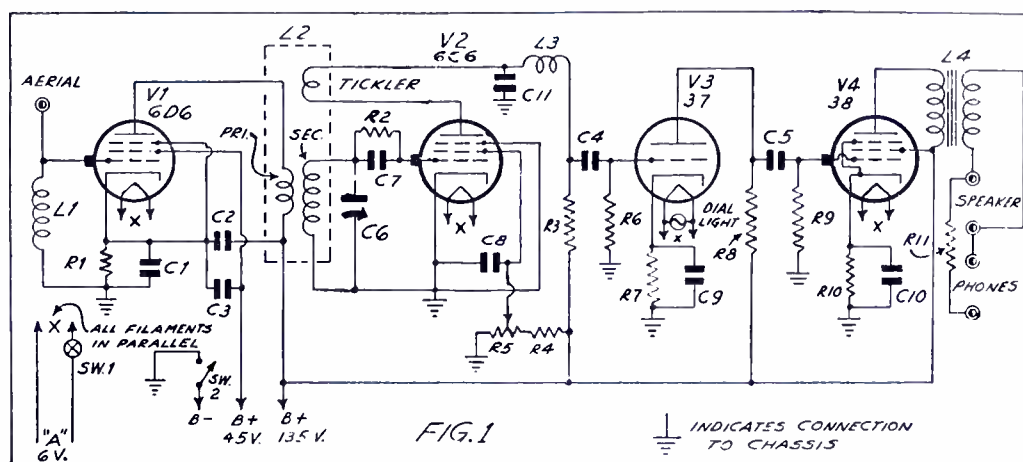

Schematic Circuit and List of Parts

- L1, L3—2½ mh. r.f. chokes (Hammarlund).
 L2—plug-in coils as described (Alden 706 SWS).
 L4—38 to magnetic speaker output transformer (Trutest).
 R1—300 ohms (Lynch).
 R2—3 megohms (Lynch).
 R3—¼ megohm (Lynch).
 R4—25,000 ohms (Lynch).
 R5—50,000 ohm potentiometer (Electrad).
 R6—½ megohm (Lynch).
 R7—3,000 ohms (Lynch).
 R8—10,000 ohms (Lynch).
 R9—½ megohm (Lynch).
 R10—1,000 ohms (Lynch).
 R11—25,000 ohms (Lynch).
 C1, C2, C3, C4, C5—.01 mf. mica (Cornell-Dubilier).
 C6—140 mmf. midget variable (Hammarlund).
 C7—.0001 mf. mica (Cornell-Dubilier).
 C8—2 mf. 500 v. electrolytic (Trutest).
 C9—5 mf., 35 v. electrolytic (Trutest).
 C10—5 mf., 35 v. electrolytic (Trutest).
 C11—.00025 mf. mica (Cornell-Dubilier).
 SW1-SW2—Double pole, double throw snap switch; only one side used (Insuline).
 One small porcelain standoff insulator for aerial connection (Birnback).
 One 6-prong Isolantite socket for plug-in coil L2 (Hammarlund).
 Two 6-prong wafer sockets for V1, V2 (Eby).
 Two 5-prong wafer sockets for V3, V4 (Eby).

- One mounting clip for grid leak R2 (Aerovox).
 One variable ratio vernier dial with 6-volt dial light (National).
 Four insulated tip jacks, for phone and speaker connection (Insuline).
 V1 type 6D6 tube (Raytheon).
 V2 type 6C6 tube (Raytheon).
 V3 type 37 tube (Raytheon).
 V4 type 38 tube (Raytheon).
 One pair featherweight phones (Trimm).
 Three 45 volt B batteries, type V-30-B (General).
 50 foot roll No. 18 flexible fixture wire, for aerial.
 9 feet double twisted lamp cord, for filament supply.
 One single contact automobile plug, for filament supply.
 One front panel, 8½" x 9", No. 14 gauge (Insuline).
 One subpanel 7" x 7¾", bent as shown (Insuline).
 Two subpanel brackets, ¼" square brass rod, 7" long, bent as shown.
 Two 1" hinges.
 One ditty box as described.
 Incidental hardware as required.

The makes of the parts used in the receiver illustrated are given in parentheses. Parts of equivalent electrical characteristics may readily be substituted at the builder's discretion.

right by a small "L"-shaped bracket. In an oblique line behind the detector tube there follow the 37 and 38 audio tubes. This irregular arrangement was followed merely because the socket holes happened to be available from one of the previous circuit attempts. The individual builder will probably follow his own taste as far as actual construction of any similar receiver is concerned.

Practically all of the various fixed resistors and condensers shown in the diagram are mounted directly by means of their own terminal leads. The regeneration control potentiometer mounts on the front panel beneath the sub-panel, with the double-pole filament switch directly in the center under the tuning knob. Along the right-hand edge of the panel are four insulated tip jacks to accommodate earphone and loudspeaker cord tips.

Special Switch Needed

A double-pole on-off switch is quite necessary in order to open the B-circuit and to thus prevent the B battery from draining continually through the regeneration potentiom-

eter. The three leads for the B batteries are flexible wire about 10" long. For filament connections, a piece of flexible lamp cord 9 feet long was fitted at one end with a single contact automobile plug. The other end is simply connected in the receiver itself. The plug is inserted in a dashboard light and filament current is thus quickly had. If no convenient outlet is available on the dashboard of the car, a simple single-contact receptacle can be mounted on it quite easily and permanent connection made to the ungrounded side of the battery.

The bottom edge of the front panel is fitted with a couple of small hinges which, in turn, are fastened to the front edge of the ditty box by means of small machine screws and nuts. With this particular ditty box, the chassis depth of 5½" brought the knob of the dial a fraction of an inch above the edge of the box. As this would prevent the cover from closing, a 1½" hole was cut in the false cover of the box top, as shown in the outdoor illustration of the receiver in action. The hinges are arranged to allow the set to swing upward toward the operator. The chassis

comes up pretty nearly at right angles and the coil socket is readily accessible for coil changing.

In order to make the tip of the 6C6 detector tube clear the inside back of the cabinet when the receiver is swung open, it was necessary to sink the socket for this tube 1" below the sub-panel by means of brass studs. This makeshift arrangement could have been avoided if the socket had been moved back about half an inch. It was just one of those little things that you discover after everything is screwed in place and it is too late to make new holes!

Getting the Aerial Up

For aerial wire, ordinary single conductor lamp cord was found best.

A 50-foot roll of this wire can be pushed comfortably inside the cover of the ditty box. In order to get the end of the wire up in a tree, it was found necessary to use a weighted string, which was twirled a couple of times and then heaved skyward. A couple of attempts is usually necessary before the cord hangs itself over a high enough limb. The cord is let out until the weighted end is within reach, and the end of the aerial wire tied on then hoisted up carefully. A hundred-foot roll of strong cord costs only 15¢ and when weighted down with a half-dozen old iron washers makes a very satisfactory support.

Small egg-type insulators for the aerial were used in some of the tests, but these were found unnecessary, as the supporting cord itself makes an excellent insulator. It is desirable, of course, to use an insulator of some sort. What was finally evolved was an insulator cut from an eighth-inch sheet bakelite. This is merely 3" long and about 1/2" wide, with a hole drilled in each end.

No ground connection is necessary, one side of the filament circuit being grounded directly to the chassis. The eventual return circuit through the car battery made the whole chassis of the car act as a counterpoise or artificial ground.

Box Not in the Way

As the ditty box closes up tight and there are no external wires or protrusions of any kind, it can be placed on the floor of the car, thrown into the rumble seat or strapped to a luggage carrier. If the box is kept on the rear floor of the car it suffers no damage if it is used as a foot rest. When a likely looking location is approached, the idea is to merely stop the car and to pull off to the side of the road. The box may be placed on the rear seat or on the running-board. The aerial is thrown up, the flexible filament wire plugged into the dashboard receptacle, and earphones and one coil plugged in. The volume is quite adequate on many stations for loudspeaker operation, and a loudspeaker can be taken along if the experimenter so desires. However, earphones are more convenient

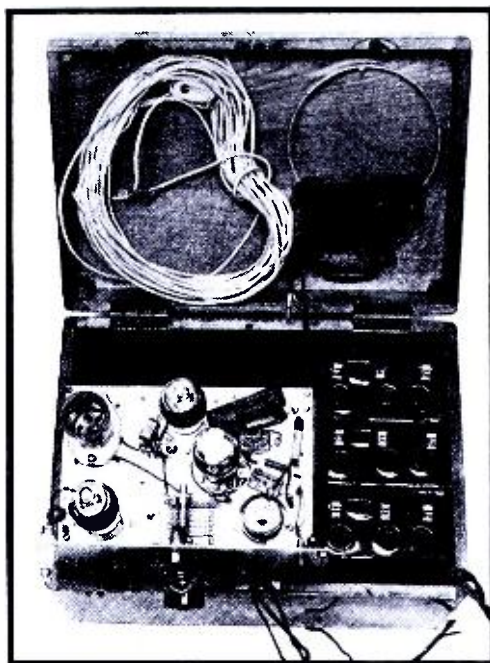

In this view the receiver chassis has been swung upward to show the parts on the subpanel, and the cover of the top has been removed to show how the aerial wire and earphones fit in the top.

and very much more sensitive. Some of the new earphones now on the market are so light that they can be worn without discomfort even in the warmest weather. It is so much easier to spot stations with a pair of phones than with a loudspeaker that the former are preferable for real DXing. Ordinary loudspeakers cannot be carried around very well and they are something of a nuisance in an automobile already filled with three or four people, beach chairs, bags and the usual other paraphernalia that somehow or other always manage to accumulate in an automobile during a trip of any kind.

The receiver shown in the accompanying illustrations is intended more as a suggestion than anything else. It shows what can be done with one particular box. Of course, boxes of different construction will require different treatment. If the experimenter is ambitious and has the parts on hand, there is no reason why he cannot build an extremely sensitive and selective superheterodyne

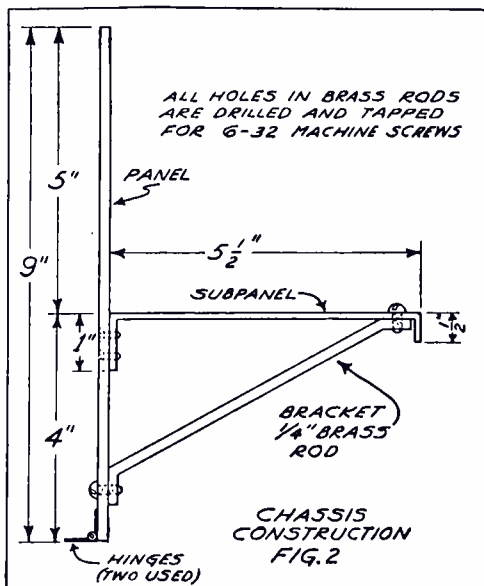

Side view of the receiver chassis, showing the method of mounting the sub-panel. There is one 1/4" brass bracket at each end of the latter.

into a case of exactly this size. The B batteries can be disposed of separately in a corrugated container tied under the dashboard or in another but smaller separate wooden box. A set of this kind will well repay its owner in excellent reception.

A Hint About the Law

In passing, we might mention that the equipping of automobiles with short-wave receivers is illegal in some states. New York, for instance, has a law to this effect, even though most law officers know very little about it. It states that it shall be a misdemeanor to equip an automobile with a receiving set capable of receiving on police frequencies. To our knowledge, no one has ever been arrested for violation of this law, so there is no judicial interpretation of the word "equip." However, a portable set of the kind described in this article can hardly be thought of as coming within the intention of this statute. An automobile carrying this receiver is in the same position as a truck carrying any short-wave receiver from one point to another. The intention of all laws of this kind is, of course, to give the police an opportunity to hold suspected criminals. Obviously, a set that requires the car to be stopped and an aerial strung up is of little tactical value to criminals effecting an escape or otherwise trying to circumvent justice. Speed is such an important element in law enforcement today that any criminal who does want to follow the police radio alarms will most certainly fit up a receiver that can be used while the car is in motion.

TABLE I—COIL DATA

Wavelength Range (meters)	For Transformer L2		
	Primary	Secondary	Tickler
10-20	4	4 3/4	4
20-40	8	10 3/4	6
40-80	14	22 3/4	7
80-200	32	52 3/4	15

The first coil is space wound twice the diameter of the wire, the second coil space wound equal to the wire diameter, and the third and fourth coils are close wound. The primary is interwound with the secondary. All coil forms are 1 1/4 inches in diameter. No. 26 D.C.C. wire used. Six prong forms.

Any standard three-winding, six-prong plug-in coils may readily be adapted to the circuit shown. It is only necessary to place the coil socket far enough back from the rear edge of the sub-panel so that the top of a coil will clear the inside of the box when the chassis is swung upward.

When changing coils, hold the chassis securely with one hand. Six-prong coils fit pretty tightly in their sockets and must be worked back and forth a little to release the base pins.

—R. H.

Some Real Information on Short-Wave Converters

By S. Miller*

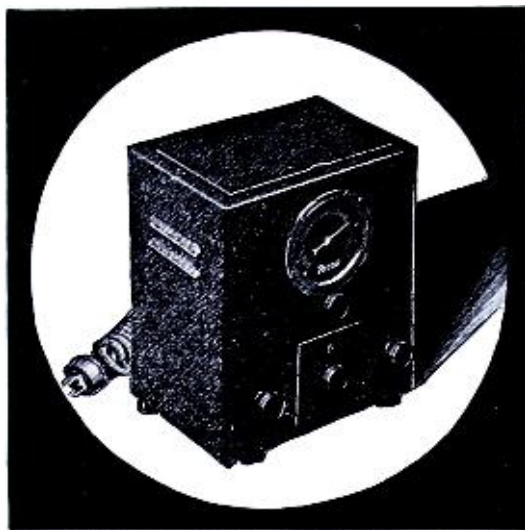

General view of the converter designed by the author and described in the text.

THE question often arises as to whether or not a combination of a high-grade converter and a fairly good broadcast set can perform as efficiently as a receiver designed specifically for short-wave reception.

A properly designed converter, coupled to an average broadcast receiver, may be more sensitive than an ordinary (or even expensive) short-wave receiver because the use of a converter automatically changes an ordinary t.r.f. broadcast receiver into a superhet, or it changes a broadcast super into a double-shift short-wave superheterodyne with three detectors and two different intermediate frequency amplifiers. (See Fig. 1.)

The basic function of all converters is to invert the high frequencies into one of the lower frequencies of the broadcast band, so that the broadcast receiver can amplify, detect and further treat the inverted frequency as an ordinary broadcast signal.

When the action of a converter is definitely limited to its basic function (only that of frequency inversion), it adds little to the selectivity or sensitivity of the receiver with which it is used. In fact, successful reception of short-wave stations is then dependent to a large extent upon the sensitivity and selectivity of the broadcast receiver. It therefore follows that while many improvised devices may properly earn the name "converter," few dependably bring in weak foreign stations with more than a satisfactory degree of volume, regardless of the receivers with which they are used.

The essential difference between the Deluxe Converter illustrated herewith, and the conventional type is that the Deluxe performs three important functions, all of which are prime requisites for short-wave reception on broadcast receivers:

1. Driftless Frequency Inversion.

Although frequency inversion takes place in all short-wave converters, the term as used here applies

to a precise form of dependable inversion all the way up to 20 megacycles (down to 15 meters) wherein the signal is not only first freed from interference and then continuously inverted to the exact predetermined intermediate frequency, but is also subsequently intensified.

Such inversion can only take place when special precautions are taken to stabilize the oscillator and adjacent circuits against frequency drift. This involves the use of a mixing system (to be later described) which presents an identical input impedance to the entire band of frequencies to be received, as well as the employment of a well regulated power supply.

2. Increases Sensitivity of Broadcast Set.

However sensitive the broadcast receiver may be, it can always be made more sensitive, for no short-wave receiving system is ever too sensitive for round-the-world reception. Inasmuch as the broadcast set will not amplify or detect any signal that is fed into it below its response level, precautions must be taken to insure the transfer of the inverted signal from the converter to the broadcast receiver with maximum intensity and minimum noise. To accomplish this, an additional high-gain, tuned i.f. stage is placed after the converter proper.

While it is true that ordinary converters which do not employ a pre-tuned stage of i.f. will operate any broadcast receiver regardless of the frequency to which the set is tuned, this condition prevents the user from properly resonating the input circuits of the receiver with the output circuit of the converter. When this detuned condition exists, there is an apparent loss of sensitivity as well as a noticeable decrease in selectivity. In some cases, two stations may be received at the same time.

The fixed tuned i.f. stage (545 kc.) employed in this converter is a feature of importance for the following reasons: First, it adds an additional high-gain stage to the receiving system and thereby increases its overall

sensitivity; second, a fixed tuned stage can readily be designed for maximum amplification and more effective suppression (rejection) of undesired adjacent frequencies; and third, the use of a pre-tuned i.f. output stage easily enables the user to "resonate" the input circuits of the set to the tuned output of the converter (by tuning the broadcast receiver for "peak" volume). When resonance is thus established, maximum transfer of energy takes place from the converter to the receiver.

3. Increased Selectivity of Broadcast Set.

Receiver selectivity is obviously of paramount importance in successful short-wave reception because increased selectivity means elimination of signal interference.

As most forms of static appear simultaneously over a wide frequency band, it follows that the narrower the band of frequencies admitted by the receiver, the lower the noise level. Therefore, the more selective a receiving system is, the more effective will be its suppression of atmospheric disturbances.

Increases Selectivity

The simple principle utilized by this converter to increase the selectivity of any broadcast receiver is based upon the fact that the degree of kilocycle selectivity of any superheterodyne is determined by the frequency of the i.f. amplifier and only comparatively little by the signal frequency. (t.r.f. short-wave receivers are dependent upon the signal frequency and tune very broadly at the lower frequencies.)

A well designed broadcast t.r.f. receiver will completely cut-out a powerful carrier which is approximately 1% off the signal frequency. In other words, a broadcast receiver with 10 kc. selectivity will eliminate the carrier frequency of a 1010 kc. signal when detuned 1% from the signal frequency (1000 kc.).

If this same t.r.f. receiver were used for short-wave reception, say on 15,000 kc. (20 meters), 150 kc. (1% of 15,000 kc.) selectivity would result. A powerful station would therefore cover 150 kc. on the dial. Because of certain limitations of coil construction, there is no way that this selectivity could be increased materially.

This same receiver is actually made 28 times more selective when the Deluxe Converter is used with it. The reason for this increase is due, as previously stated, to the fact that the frequency selectivity of a superheterodyne receiver (which is what

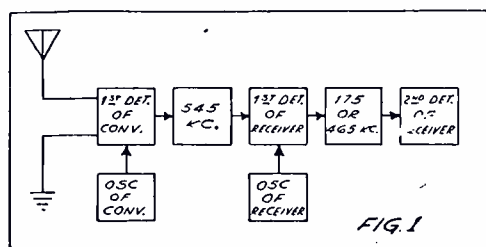

Block diagram showing a double superheterodyne resulting from use of a converter with a broadcast receiver of the superhet type.

* Chief Engineer, Postal Radio.

results when the converter is used with a standard broadcast set) is dependent upon the intermediate frequency and only to a small extent on the signal frequency. Thus with an i.f. of 545 kc. and a selectivity of 1%, complete suppression of powerful carriers will take place when the i.f. (or the signal frequency) is off resonance 5.45 kc., which is approximately one twenty-eighth of the 150 kc. selectivity of the t.r.f. receiver operating on the same signal frequency.

Coil Changing System

A few words regarding the relative merits of switching arrangements and plug-in coils might not be out of place.

Both have their advantages and disadvantages. Plug-in coils, although conceded to be the more efficient, are frequently improperly adapted for use in short-wave receivers. Some improvised method for holding the coil is nearly always used, such as tube-like prongs on the form fitting into tube sockets. Plug-in coils are also usually unprotected from mechanical injury. Constant handling of exposed coil windings invariably produces a change of inductance by some slight shifting of the wires or accidental abrasion. Such a condition naturally impairs the performance of any short-wave device.

Most switching arrangements, on the other hand, although free from the evils associated with plug-in coils and extremely convenient, are nevertheless characterized by a number of inherent losses due to objectionable stray capacity of the switch itself and its associated wiring, "dead end" effects of unused turns, or other coupling losses introduced by "idle coils."

From a standpoint of design, we feel that the coil changing system employed in the Deluxe Converter has noteworthy and commendable features.

In order to combine into one band-changing system the convenience of switching arrangements together with the efficiency of plug-coils, an improved type of shielded duplex coil catacomb and receptacle was developed.

The duplex drawer coil unit is composed of two precision space wound coils fully shielded from each other, but contained within one catacomb drawer with its contacts so arranged that the entire unit slides into its receptacle through the front of the panel, like the drawers of a desk.

Although this system leans toward the plug-in arrangement, it nevertheless retains nearly all of the convenience of switching arrangements, for both coils and their combined shields are placed in the correct position simply by the insertion of the drawer, without opening the cover of the receiver or otherwise disturbing its position or arrangement.

The cadmium plated steel receptacle into which the duplex drawer coils slide acts as an additional coil shield and is equipped with eight double-spring, butt-wiping and self-cleaning contacts which are in no small measure responsible for the permanent operation of this band changing system.

Needless to say, the subject of contacts is of utmost importance in any short-wave plug-in or switching device and deserves considerable attention, for the efficiency of the most elaborate equipment is definitely limited by the contacts employed therein.

Inasmuch as many circuit noises are traceable to varying resistances at points of "change-over" contacts, the prime requisite for such contacts is obviously the maintenance of a perfect non-reactive and unvarying path of conduction throughout its useful life.

The resistance and reactance of contact points depend on several factors, namely: pressure, surface area and the condition of the contacting surfaces. In order to obtain maximum pressure at the point of contact, the receptacle for the drawer coils is equipped with contacts composed of two springs, one made of phosphor bronze, for contact, and the other of tempered high carbon steel (similar to clock springs), for tension. This tension spring absorbs all bending stress, so that the phosphor bronze contact spring is relieved from almost all of the pressure strain and is primarily used to present a large self-wiping, non-oxidized surface to the coil studs. This type of contact is capable of passing large currents and has actually been found to improve with age, because continued use gradually wears off slight irregularities on both the contact spring and the coil stud.

Let us consider for a moment the importance of shielding in short-wave equipment. Improper shielding is responsible for a large share of noise introduction and loss of selectivity. Stray feedback, always

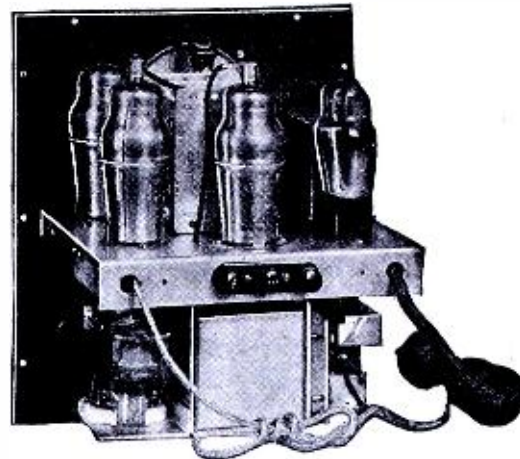

Inside view of the author's converter, which is entirely self-powered.

caused by improper shielding or wiring, reduces the gain ahead of the first detector. While it is true that shielding generally prevents feedback, it does so by bypassing stray and some useful r.f. currents to ground, particularly if the narrowest side of the coil shield measures less than twice the diameter of the coil. It is for this reason that the coils employed in the Deluxe Converter are wound on special forms in order to minimize eddy current losses.

For a long time aluminum has been considered the ideal shielding material for high frequency work. Experiments have proven, however, that cadmium or copper plated steel is just as effective at high frequencies and, because of its magnetic properties, is better for elimination of hum and other low frequency interferences. Inasmuch as flimsy shields are worse than no shields at all, because they introduce considerable noise by imperfect contact, the duplex drawer coil shields are of one piece construction with a twelve-point welded compartment separator.

In order to produce a high r.f. voltage on the grid of the first detector, a high L/C ratio is employed; that is, a large inductance and a small capacity are used in

(Continued on page 38)

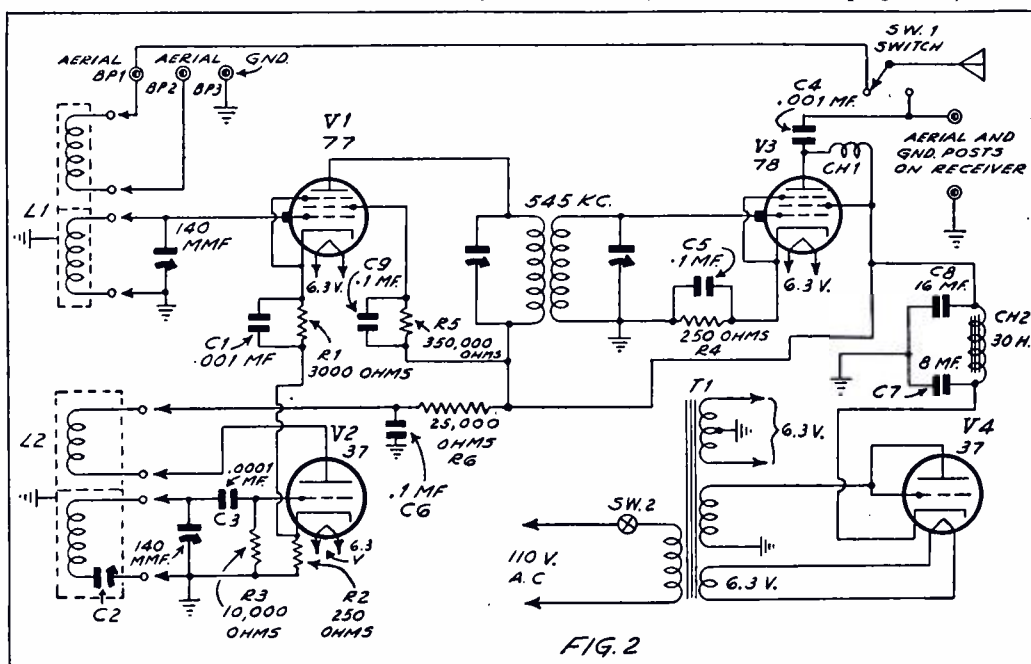

Complete schematic diagram of the converter discussed in Mr. Miller's article. The electrical values of all parts are indicated.

A Low-Noise Level Superheterodyne

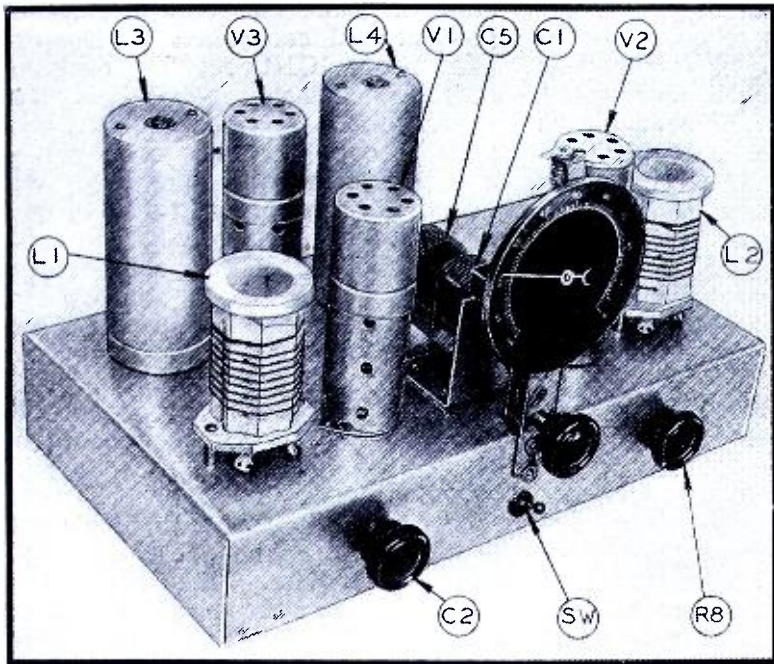

SUMMARY: *The noise level in superheterodynes seems to be receiving a great deal of attention of late. As pointed out many times, the noise level is primarily a function of the gain in the first stage, so that anything that will increase the gain in this stage will automatically result in a reduction of the noise level.*

Mr. Worcester increases the effective amplification in the mixer stage by raising the oscillator voltage, since the i.f. voltage in the output of the mixer varies directly as this voltage. Full constructional details are given.

THERE is a mistaken conception on the part of some uninformed radio listeners that the more tubes a receiver has the more sensitive it necessarily must be. However, many listeners who have purchased multi-tube short-wave or all-wave receivers have found that it is not possible to excel, and in many instances not even equal, the performance of simple regenerative receivers.

The truth of the matter is that, although the actual amplification of one of these receivers may be tremendous, unless the gain obtained is greater than the thermal agitation and shot-effect noises produced in the tubes and associated apparatus, the actual increase in "sensitivity," in the sense of ability to tune in weak stations, will be negligible. It should be pointed out, however, that such a receiver will be infinitely superior to a regenerative type of receiver as regards selectivity and ease of control.

Reducing Receiver Noise

It is possible, by suitable design, to reduce the receiver noise in a superheterodyne to a point where substantially weaker signals than can be heard with a regenerative type of receiver can be received with extremely low noise level. As has been pointed out recently, the noise produced in a receiver is inversely proportional to the gain in the first tube. In the interests of low noise level, therefore, it is necessary to produce the greatest gain possible in the first tube.

Several methods of increasing the gain in the first stage have been employed. For broadcast reception, a preselection stage of r.f. is frequently used, since the gain in the r.f. stage can be made about three times as large as that possible in the mixer. Another object of the preselection stage, of course, is to decrease image interference. At short waves, however, it is not possible to obtain appreciably greater amplifi-

By J. A. Worcester, Jr.

cation in the r.f. amplifier than in the mixer stage; particularly at the higher frequencies.

In a receiver described by the writer in the June issue of this magazine, two mixer tubes connected in parallel were employed to increase the mixer stage gain. The main difficulty with this system is that the use of two tubes, theoretically, only about doubles the gain, so that to increase the gain by as much as threefold in practice would require at least four parallel operated tubes.

Regeneration in R.F. Stage

Another theoretical method of increasing the first stage gain would be the application of regeneration to the first stage, which may be either an r.f. preselector or mixer. This procedure would introduce serious difficulties, however, in the form of interlocking controls, dead spots, and the general inconvenience of adjusting a rather critical regeneration control.

In the receiver to be described, the gain in the mixer stage is increased manifold by the application of still another principle. Without going too deeply into the theory of superheterodyne operation, it can be said that the intermediate-frequency signal produced by the mixer stage is proportional to the product of the received signal and the amplitude of the locally generated oscillations. The principle involved in this receiver, then, for the purpose of obtaining a high gain in the first stage, with a consequent reduction in receiver noise, is to apply an unusually strong locally generated signal to the mixer tube.

The practical accomplishment of this idea required the development of a new method of coupling the oscillator to the mixer. As is well known, the amount of oscillator voltage introduced on the mixer-tube grid is generally very small, and is usually introduced by means

of a small coupling coil or condenser. Now, if an attempt were made to increase the oscillator input by employing the whole voltage developed across the oscillator grid coil, satisfactory results would be impossible due to interlocking of the controls. Furthermore, there would be considerable radiation from the antenna, which is undesirable from the standpoint of interference with neighboring receivers.

Both of these difficulties were avoided in this receiver by introducing the oscillator voltage in the suppressor grid circuit. The method of connection is obvious from an inspection of the schematic diagram of Fig. 1. It will be noted that the entire voltage developed by the oscillator is introduced into the suppressor grid circuit of the mixer tube. The return of the oscillator grid coil is brought back to the cathode of the mixer in order to maintain the mean suppressor-grid bias at zero.

Preventing Overload

When employing this method of obtaining high gain in the mixer circuit, it is necessary to carefully design the remainder of the circuit in order to prevent overloading of the i.f. amplifier and second detector. This may be better understood when it is remembered that, while the intermediate frequency may be modulated by as much as 40% or more in an ordinary superheterodyne receiver, in this circuit the a.f. modulation is only 5% or thereabouts. Consequently, the amplitude of the i.f. signal on the grid of the second detector will be equal to that on the a.f. amplifier grid if a gain in the second detector of 20 is assumed. For this reason, a 2A5 tube is employed as a second detector as well as a power amplifier.

Only one stage of i.f. amplification is employed in order to prevent overloading of the second amplifier grid. This considerably simplifies the construction of the receiver, as no particular difficulty should be

experienced in obtaining satisfactory operation of a single stage of i.f., while, when two stages are employed, extreme care is necessary in the layout and wiring if difficulties from oscillation are to be avoided.

One of the most useful gadgets that it is possible to incorporate in a short-wave superheterodyne is a beat frequency oscillator. This device is a necessity for continuous wave (c.w.) reception and is also a great aid in locating the carriers of short-wave broadcast stations. Previously, however, it has generally been found necessary to go to the expense and trouble of employing an additional transformer and tube for this purpose. In this receiver, however, a new oscillatory circuit has been developed in which only the winding L7, in series with the cathode lead of the second detector, is required for beat reception. This winding merely consists of about 45 turns of No. 30 d.s.c. wire wound on a 1" dia. form, 2" long. This winding is mounted underneath the chassis and does not have to be in inductive relation to the windings of L4.

The beat frequency oscillator is turned on and off by means of the switch SW. Another important feature of this circuit is the introduction of regeneration in the second-detector circuit by means of the variable resistance R10. Once this

control is adjusted for optimum results, it may be ignored entirely. To this end, it is mounted at the rear of the chassis so that it will be out of the way and so discourage as much as possible the natural tendency of the operator to twist all the dials he can lay his hands on when "tuning in" an elusive station. To adjust this control, the switch is closed and the resistance increased until the circuit is just on the verge of oscillation. Of course, when the switch is opened, the circuit should oscillate, and is the switch position used for beat frequency reception.

The increase in sensitivity and selectivity produced by regeneration in the second detector is quite surprising. By backing down the regeneration control to zero resistance, a convincing demonstration of the effectiveness of this control in increasing volume is readily possible.

The Receiver

To get down to the details of the actual receiver incorporating the above mentioned principles, the tubes employed are a type 57 mixer, a type 56 oscillator, a type 58 i.f. amplifier, a type 2A5 second detector, and another type 2A5 as an audio amplifier. Aside from the features previously discussed, the design of the frequency converter is quite

conventional. The two circuits are ganged and controlled by the dual condensers C1-C5. The dial employed is of the gear-driven airplane type, which provides an extremely satisfactory control for general short-wave work. The ease with which the mechanism turns is quite a pleasure, especially when compared to the usual type of friction drive.

The plug-in coils are of the manufactured variety and were used here since they simplify to a considerable extent the construction of the receiver. Without considering in detail the mechanics of the problem, it is necessary to remove some turns from the oscillator grid coil in order to obtain proper tracking of the ganged circuits. The reason, of course, is that the frequency of the oscillator differs from that of the antenna coil by the amount of the intermediate frequency, which, in this instance, is 465 k.c. It is also necessary to employ a small variable padding condenser, C2, in order to cut down the frequency coverage of the tuned circuit L1-C1. If the changes in the oscillator-coil grid turns are properly made, the padding condenser C2, will not have to be varied appreciably with different values of the tuning dial. There will be a different setting of C2 for each coil range employed. For the larg-

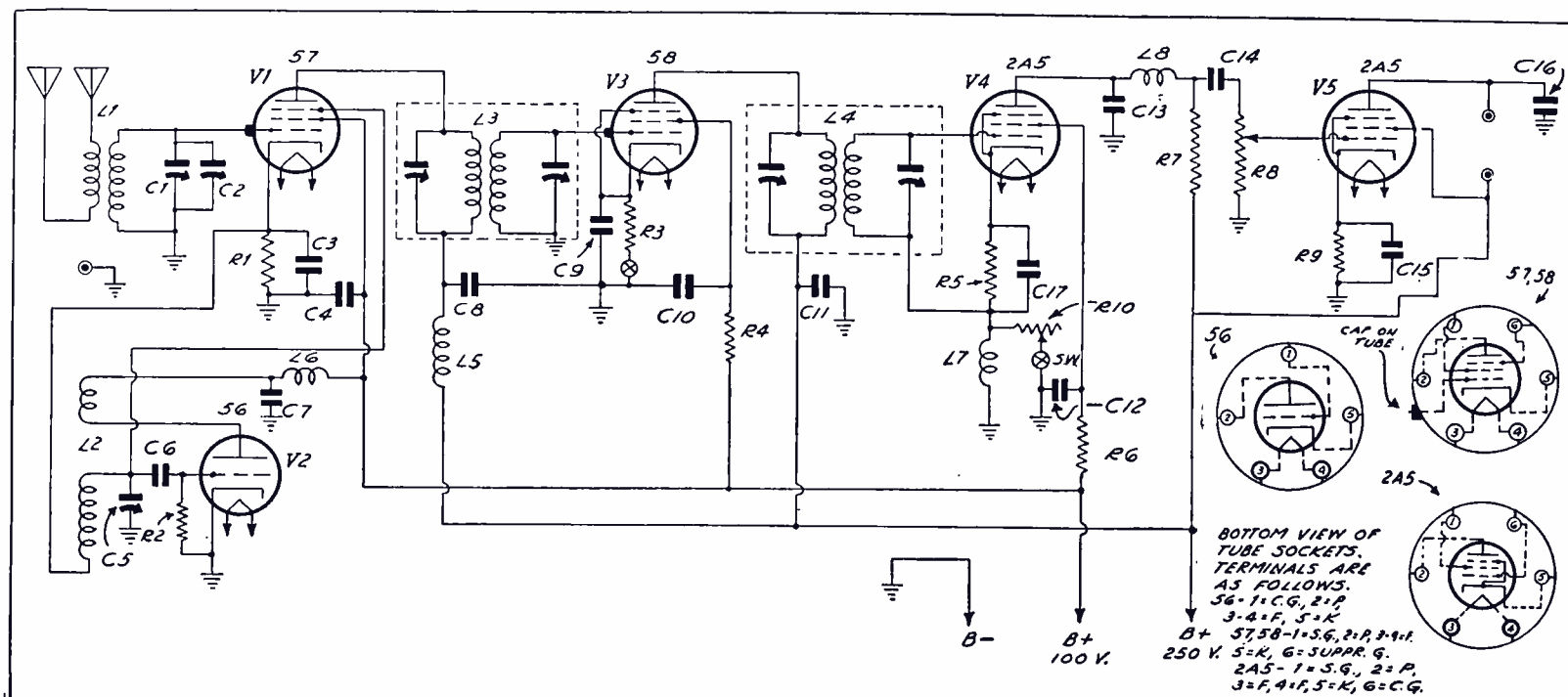

Complete schematic circuit and list of parts for the special low-noise superheterodyne discussed by the author.

PARTS REQUIRED

- L1, L2—Two sets of I.C.A. 4-prong Insulex plug-in coils, 18-200 meters, one set altered as per text.
- L3, L4—Hammarlund 465 k.c. air-tuned intermediate-frequency transformers.
- L5, L6—Hammarlund 2.3 mh. midget r.f. chokes.
- L7—B.F.O. coil. 45 turns, No. 30 d.s.c. wire wound on a 1" dia. bakelite form.
- L8—Hammarlund 85 mh. r.f. choke.
- C1, C5—Hammarlund dual 140 mf. isolantite midget condenser, type MCD-140-M.
- C2—Hammarlund 20 mmf. variable condenser, type MC-20-S.
- C3, C7—Cornell-Dubilier .001 mf. mica condensers.
- C4, C14, C17—Cornell-Dubilier, .01 mf. tubu-

- lar bypass condensers.
- C6—Cornell-Dubilier .0001 mf. mica condenser.
- C8, C9, C10—Cornell-Dubilier .1-.1-.1 mf. multiple section paper by-pass condenser.
- C11, C12—Cornell-Dubilier .1-.1 mf. multiple section paper by-pass condenser.
- C13, C16—Cornell-Dubilier .0005 mf. mica condensers.
- C15—Cornell-Dubilier 25 mf. 25-volt dry electrolytic condenser.
- R1, R5—Lynch 10,000-ohm metallized resistors.
- R2, R6—Lynch 100,000-ohm metallized resistors.
- R3—Lynch 400-ohm metallized resistor.
- R4—Lynch 2000-ohm metallized resistor.
- R7—Lynch 50,000-ohm metallized resistor.

- R8—Centralab 500,000-ohm Elf potentiometer.
- R9—Lynch 500-ohm metallized resistor.
- R10—Centralab 10,000-ohm Elf potentiometer.
- 4—I.C.A. 6-prong wafer sockets.
- 1—I.C.A. 5-prong wafer socket.
- 3—I.C.A. knobs.
- 1—Crowe type 120 gear driven airplane type dial.
- 1—Blan Toggle switch.
- 3—Hammarlund tube shields.
- 1—Eby triple binding post strip.
- 1—Eby twin speaker jack.
- 1—Blan chassis, 14" x 8" x 2 1/2".
- 1—type 57 tube.
- 1—type 58 tube.
- 2—type 2A5 tubes.
- 1—type 56 tube.

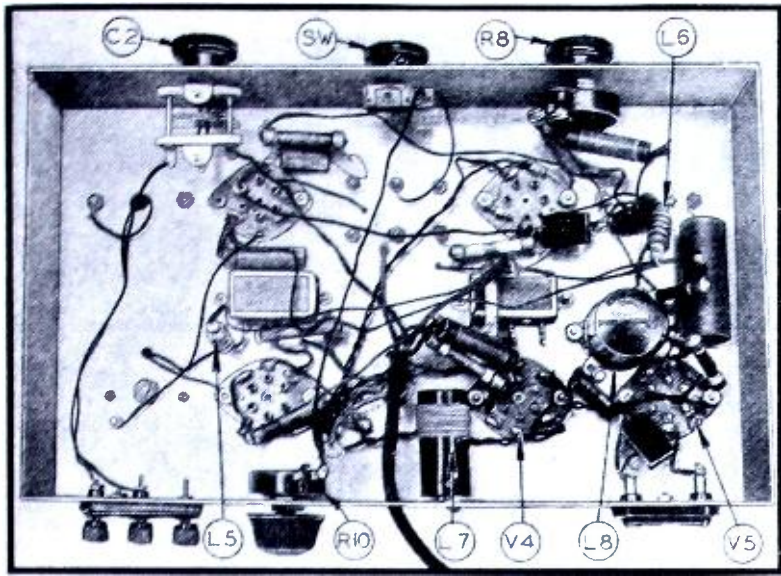

Under-view of the receiver showing the location of the parts under the deck. Note the location and construction of the choke, L7, described in the text. The regeneration control in the second detector, R10, may also be seen.

est coils, C2 should be about all in for resonance; while with the next to the smallest coil, C2 will be only slightly meshed. As no turns are removed from the smallest oscillator grid coil, the setting of C2 may vary slightly with dial setting, and generally will have two values for maximum response.

To properly alter the oscillator coils, remove 14 turns from the lower end of the grid winding of the largest coil, 5 turns from the next largest, and 1½ turns from the next to the smallest coil. No changes are made in the smallest coil. Final coil data are given in Table I.

Mechanical Details

As will be noted from the photographs, the frequency changing equipment is mounted along the front of the chassis, while the intermediate amplifier, second detector and audio amplifier are mounted at the rear. The wiring of these latter units is quite conventional and requires no special comment. It will be noted that the volume is controlled in the audio circuit by means of the potentiometer R8.

The various fixed condensers, resistors, sockets, chokes, etc., are mounted underneath the chassis, which, incidentally, is formed from 14 gauge aluminum and measures 14" x 8" x 2½".

In wiring the receiver, it will be found necessary to remove the grid lead from the second intermediate-frequency transformer and substitute a longer one which is led through the bottom of the transformer and connected to the grid terminal of the 2A5 second detector. It should also be pointed out that neither terminal of condenser C17 is grounded. If one terminal of this condenser is grounded, the beat frequency oscillator will refuse to work, since the r.f. is immediately bypassed to ground. The polarity of the condenser C15 should, of course, be observed when wiring. The proper procedure is to connect the positive terminal to the cathode.

To put the receiver into operation, insert the various tubes and a

set of coils in their respective sockets. For this purpose, the next to the smallest coils will be suitable, since they tune in the 49-meter broadcast stations.

It will be noted from the schematic diagram that provision is made for operation with a two-wire antenna feeder. If an ordinary antenna is used, connect it to the outside terminal and strap the ground and center terminal together. If an external ground connection is em-

ployed, connect it to one of these latter terminals.

The power supply connections should now be made. The heaters require a supply capable of furnishing 2½ volts at about 7 amperes. The plate voltage supply should furnish 250 volts at about 60 ma. and should have a tap providing 100 volts for the screens and the oscillator. It goes without saying that the plate supply should be very well filtered, and contain at least two good chokes and not less than 16 mf. of filter capacity.

Connect a pair of phones or a magnetic loudspeaker in the speaker jack. Headphones are to be preferred for this purpose, as it is much easier to hear what is going on.

Now, flip the switch turning on the beat frequency oscillator and tune for a carrier squeal. When the condenser plates are about two-thirds meshed, it should be possible to pick up the carrier of a 49-meter broadcast station. When this is done, turn the beat frequency oscillator off and readjust the tuning control for exact resonance and adjust the trimmer, C2, for maximum response. This latter condition should obtain with the plates nearly
(Continued on page 40)

TABLE I—COIL DATA

Wave Band (Meters)	MIXER COIL				OSCILLATOR COIL			
	Secondary			Tickler (Close Wound)*	Secondary			Tickler (Close Wound)*
	No. Turns	Wire Size	W'n'd Len.		No. Turns	Wire Size	W'n'd Len.	
12—24	8	18 enam.	1½ in.	6	8	18 enam.	1½ in.	6
22—48	15	20 enam.	1½ in.	8	13½	20 enam.	1½ in.	8
45—100	27½	26 enam.	1½ in.	19½	22½	26 enam.	1¾ in.	19½
90—200	51	26 enam.	1¼ in.	25	37	26 enam.	7/8 in.	25

*All tickler coils are wound with No. 26 enameled wire.

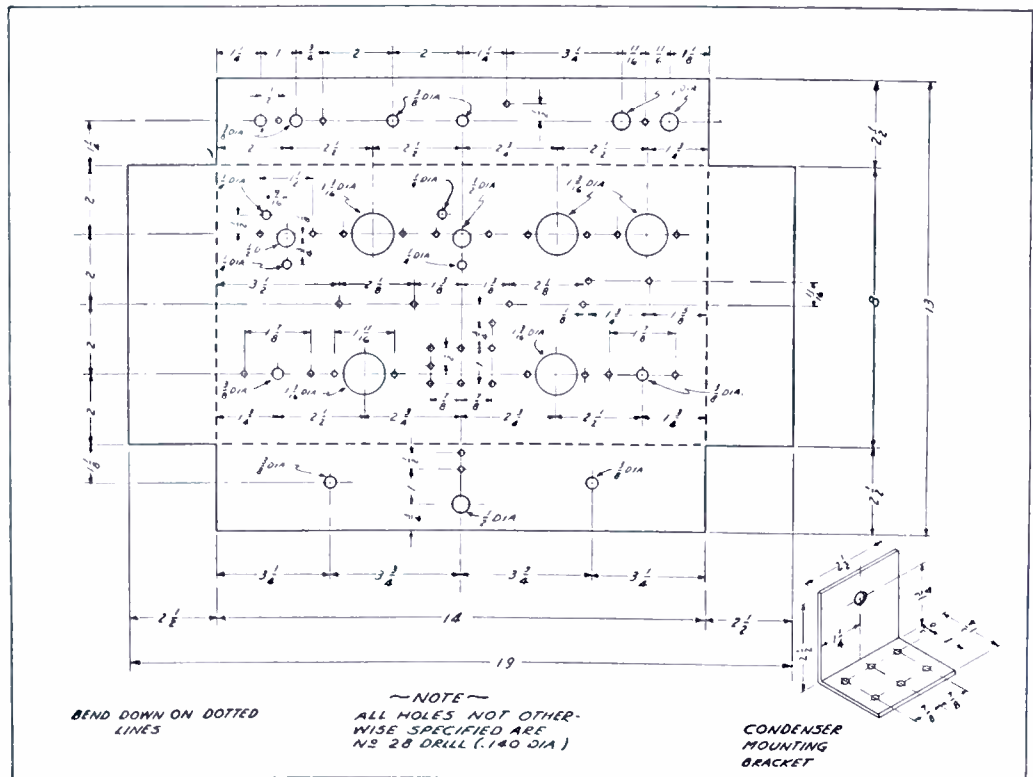

Mechanical details of the chassis and the bracket used for the tuning condenser.

How to Build A Sensitive 4-Tube S.W. Receiver

By T. C. Van Alstyne

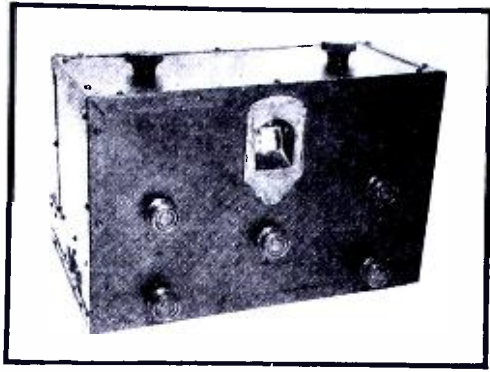

Fig. 2—Panel view showing the controls. The two knobs on the top are merely handles.

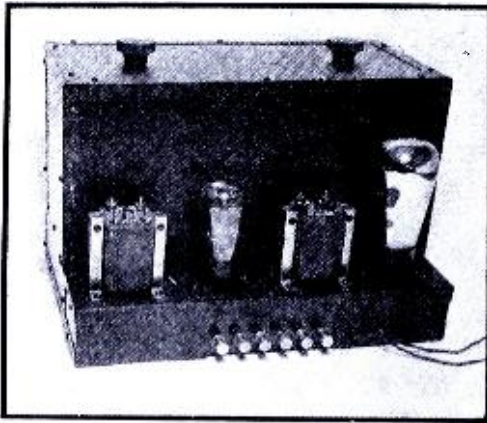

Fig. 3—Rear ledge of the set showing the location of the audio tubes and chokes.

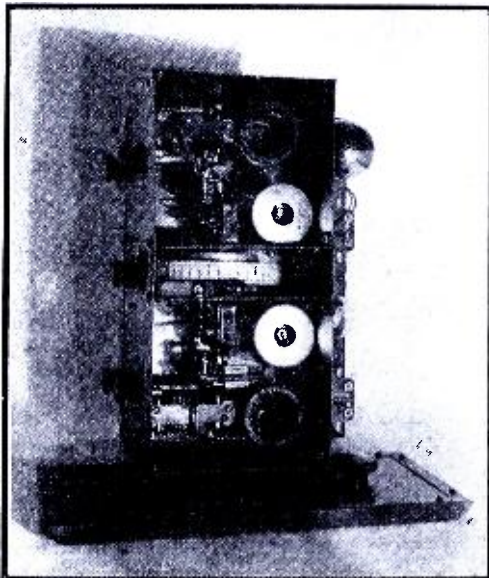

Fig. 4—The arrangement of the parts within the shield cans is shown in this view.

THE short-wave listener who demands a highly efficient receiver which is simple to construct at low cost may find his ideal in the circuit and mechanical arrangement described and illustrated herewith. Unusual sensitivity and selectivity are obtained by the use of a type 58 tube as a tuned r.f. amplifier and another as the detector; yet, the compact cabinet design permits very simple construction. The performance of the one built by the author is nothing short of remarkable, even when judged by present-day standards. Stations in nearly every part of the world are heard regularly and the apparatus has given no trouble over a long period of use.

Although the builder may vary the size and detail of the cabinet-shield to suit the requirements, he will be

SUMMARY: *Stability and reliability are the outstanding characteristics of the receiver described by Mr. Van Alstyne in this article. It has four tubes in a modern circuit arrangement, a tuned r.f. stage ahead of the detector, and a well-balanced audio system. It may be powered either by batteries or a power pack. For the man who wants a real short-wave broadcast set, we recommend this four-tube receiver.*

well advised to adhere to the three-compartment scheme with the tuning drum mounted between the two upper compartments which contain the r.f. and detector units. The connections from these sections are made in the third compartment, the sub-panel section, which is two inches deep and the full size of the receiver's base. A glance at the photographs will make the general layout clear.

While sheet aluminum will be preferred by many, the writer used sheet steel of a light gauge with excellent results. It is inexpensive and easy to work. The corners are joined with angle material of the same gauge and bolted with 6/32 machine screws. The whole was sprayed with Duco when ready to receive the components and wiring. Any paint shop will do the decorating for next to nothing.

The Controls

Five knobs appear on the front panel, as will be seen from Fig. 2; but the receiver is single controlled. The knob shown below the dial tunes C1 and C2, which are ganged together at the tuning drum by flexible couplings. Do not attempt to get along without the flexible couplings, as mechanical alignment perfect enough to insure smooth tuning over the complete scale is more difficult than it may seem at first thought. The upper two knobs adjust the resonating condensers C3 and C4. The volume control, R3, is manipulated by the lower left knob while the lower right one is the regeneration control, R10. The two knobs seen on top are but handles to remove the cover.

Two phone jacks whose terminal ends protrude into the sub-panel compartment are fitted at the lower left end of the receiver. One is for headphone use with but one stage of audio, the type 56 tube. The other is wired to include the type 47 second amplifier for loudspeaker service. If not desired, the loudspeaker stage may be omitted entirely. In this event, the phones would contact to the two outside terminals of the d.p.d.t. jack as shown in the diagram

of Fig. 1, and a single-circuit jack may be substituted. The impedance L5, the audio transformer T1, and both the audio tubes are contained on the rear ledge as shown in Fig. 3. The remaining impedance, L6, is under the sub-panel. The functioning of the impedances is important. An audio transformer with its primary and secondary connected in series will do nicely for each, but chokes designed for the purpose are preferable.

Arrangement of Parts

The arrangement of the parts within the two upper shielded compartments will be obvious from the photograph of Fig. 4. Wafer type sockets are used for the tubes and coil forms so all the connections may be made in the subpanel section. Each of the type 58's is isolated by a tube shield.

The coils are wound on 1½", five-prong forms. Two are necessary for each band. Four pairs will cover the complete range between 20 and 200 meters. (See coil data at the lower left of the circuit diagram.) L1 and L2 are wound on the same form about ¾" apart, as are L3 and L4. In the case of the coil L1-L2, one of the five prongs will have no connection. No. 34 d.c.c. is used for winding the first two coils shown in the coil data, and No. 20 d.c.c. for the other two. The winding of L1, L2 and L3 presents no difficulties. L4 has a regeneration tap which occupies the fifth prong of the coil form. Some experiment with this tap may be necessary, as the exact adjustment may vary slightly with every receiver. The turn indicated in the coil data will serve as a guide to what will be required. Remember that increasing the number of turns between the tap and the grounded end of the coil will cause freer oscillation, while reducing the number of turns will have the reverse effect. A point should be selected where the detector just oscillates with the regeneration control, R10, set about half way. It is, perhaps, needless to say that all coils should be wound in the same direction.

It should be understood that the

List of Parts

- C1, C2—100 mmf. variables.
 C3, C4—35 mmf. variables.
 C5, C6, C7, C8—.01 mf.
 C9, C10—1. mf.
 C11, C12—100 mmf.
 C13—250 mmf.
 C14—.01 mf.
 T1—Low ratio audio transformer (3-1).
 L5, L6—Impedances. See text.
 R1—5 megohms.
 R2—300 ohms, 2 watt.
 R3—20,000-ohm potentiometer for volume control.
 R4—50,000 ohms.
 R5—14,000 ohms, 5 watt.
 R6—5,000 ohms, 5 watt.
 R7—100,000 ohms.
 R8—1 megohm.
 R9—2,000 ohms.
 R10—50,000 ohm regeneration control, potentiometer.
 R11— $\frac{3}{4}$ megohm.
 R12—450 ohms.
 R13—20 ohms center tapped.

The coils L1 and L2 are wound on the same form, $\frac{3}{4}$ " apart, as are L3 and L4. See coil data at lower left of diagram and refer to text.

Fig. 1—Schematic circuit, socket connections and coil data for the receiver. See the text for further details of the circuit and arrangement of parts in the shields.

coil data given can to some degree be only approximate. The tuning range of any pair of coils will be affected by the distributed capacity throughout the receiver, the thickness of insulation on the wire used for winding, and the minimum capacity of the tuning condensers C1 and C2. The windings L1 and L3 are not critical and will need no revising. Should too much overlap or a frequency gap occur between coils, remember that adding turns to L2 and L4 will increase the wavelength or decrease the frequency. Inversely, removing turns will decrease the wavelength or increase the frequency. Any adjustment of the number of turns made on L2 *must be duplicated* on L4. That is, L2 and L4 must always have the

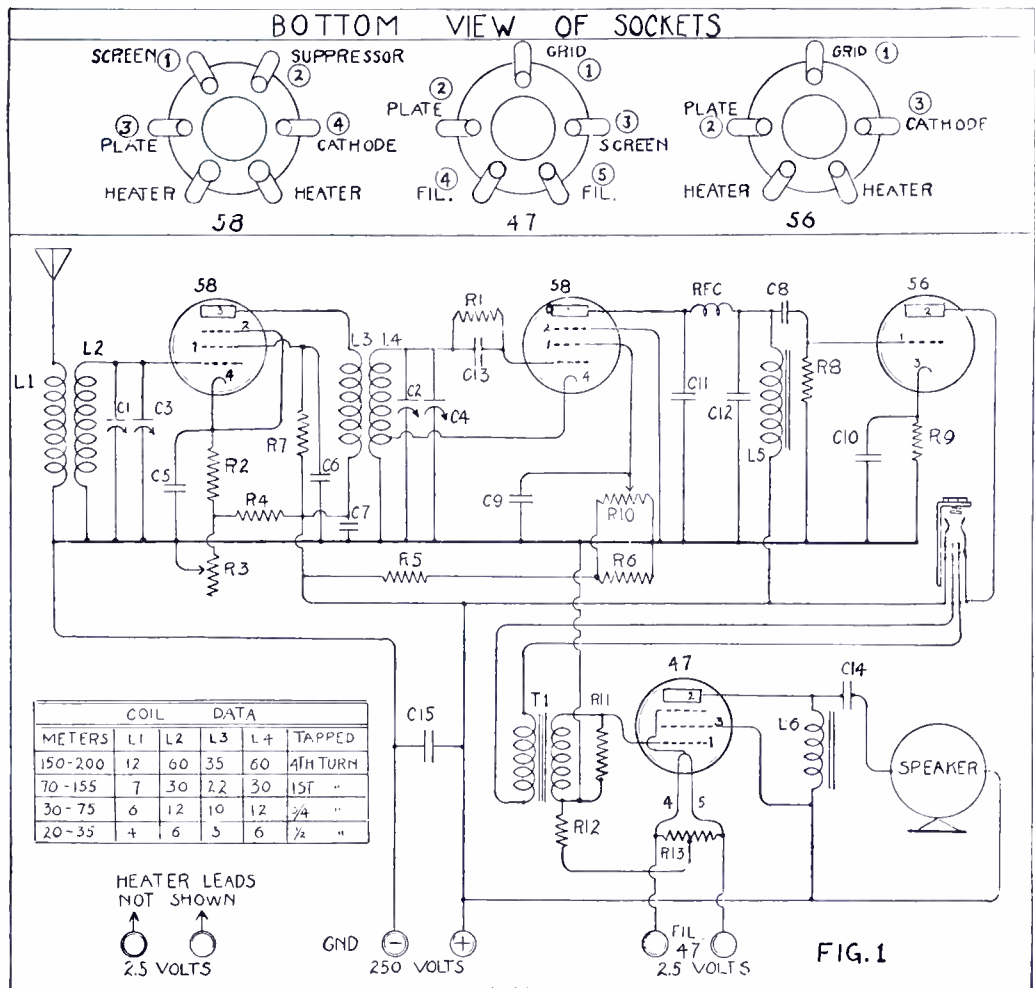

same number of turns, otherwise the tuning condensers C1 and C2 would not track.

All r.f. ground connections should be made to the same point. Do not rely on aluminum or steel as an r.f. conducting medium. The time spent in fastening a copper strip to the sub-panel for purposes of making connections will be well invested. The heaters of the type 58 and 56 tubes are connected in parallel and not shown in the circuit diagram. A separate winding on the power supply is necessary for the type 47's filament if used. If the condensers C1 and C2 are not equipped with pig-

tail leads, these should be added as reception on the high frequencies may otherwise be noisy.

When the receiver is ready for use the owner should familiarize himself with the operation of the resonating condensers C3 and C4. They need be used but little. Simply set the right-hand one to the point where maximum volume is secured when the first station is tuned in with the tuning control and adjust the left one, which is not very critical, in a similar manner. They need not then be varied as long as the same set of coils are used. Repeat the process when coils are changed.

Vernier Tuning Dials

TO obtain slower tuning condenser movement than is ordinarily obtainable with standard "vernier" dials, many experienced short-wave fans drive one such dial by another dial. They simply remove the control knob from the regular dial, and mount the second dial over the exposed shaft, at the same time supporting the extra dial by means of short brass studs or piles of washers. While the set takes on a somewhat incongruous appearance, the improvement in operating convenience is well worth while.

Dial manufacturers have finally recognized the crying need for better control mechanisms, and will soon have some radically different dials available to short-wave set users. The general trend is toward a double speed arrangement, with a reduction speed of 6:1 for quick coverage, and as high as 80:1 for fine ether-hunting.

Tickler Housing for S.W. Coils

When attempting to wind my short-wave coils on an old tube base, I found that I did not have sufficient room for the tickler, so I tried the stunt illustrated herewith. A short piece of dowel rod was used as the form on which the tickler was wound. I then fastened the form inside the coil as shown by inserting a screw in a hole drilled in the bottom of the base. The tickler

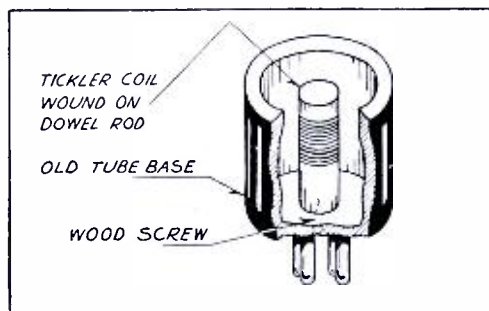

The primary is wound on a separate spool.

can also be fastened by gluing the coil on the inside of the base.

Although this idea may be used on all the short-wave coils with success, it is especially applicable to the coils for the higher bands.

Arthur Kopecky,
 934 Longwood Ave.,
 Bronx, N. Y.

Cross-Talk and the 58

Do not think that just because you use a variable-mu tube, such as the 58, that the so-called cross-talk type of interference will be eliminated. This type of interference will be minimized when this type of tube is used only if the signal is large and the volume is reduced by variation of the control-grid potential. When the signal is weak, the same amount of interference will be received with almost any type of tube.

The 34, 35, 51, 58, 78, and 6D6 are variable-mu tubes.

Summer Time is Vacation Time

We extend a cordial invitation to all amateurs to look in at LEEDS. We are now equipped to give better service. Greatly increased window space and a larger store is just another step forward in our continued growth.

NATIONAL

After four years rapid radio growth, the SW-3 still remains the standard of comparison for tuned r. f. receivers.

A.C. 2½ v. }
D.C. 6 v. } **\$17.70**
D.C. 2 v. }

All short-wave and band-spread coil ranges..... **\$3.00**

NEW! We are pleased to announce that we have been appointed New York Distributors for "MYCALEX" developed by General Electric. Mycalex is not only the finest insulation, but unlike ceramic insulation, it can be sawed, drilled and tapped to suit your particular requirements.

Sheet Form		Round Rods	
Thick	per sq. in.	diameter	Linear In.
1/8"	.03	1/8"	.05
3/16"	.04½	5/8"	.08
1/4"	.06	3/4"	.12
3/8"	.09	7/8"	.16
1/2"	.12	1"	.22
5/8"	.15	1 1/8"	.46
3/4"	.18	1 1/4"	.75
7/8"	.21	2"	.87
1"	.24		

Mycalex strips for Cardwell condensers will improve their efficiency. Undrilled strips large enough for all midway condensers 35c Transmitting size T-199—T-183 &c., 55c.

TRIPLETT METERS and service equipment

We carry the complete line of this high grade, low cost precision apparatus. For example 3½" bakelite case Milliammeters 0-5 mils to 0-1000 in all standard ranges..... **\$3.75**

Thermo Ammeters 3½" bakelite case, 0-1—0-2½—0-5 Special. **\$6.55**

Descriptive bulletin on the complete line is yours for the asking.

In stock—The Improved WING TRANS-RECEIVER, using the rugged 6 volt tubes. This unit is outstanding due to its durable construction, excellent receiver sensitivity and large power output, to say nothing of its low price, stripped..... **\$16.50**

With tubes, \$18.25. Bronze steering column mounting \$1.75. We recommend the use of the Mallory type 11 eliminator for "B" supply.

The Radio Amateur has found it convenient to shop at LEEDS. Only quality merchandise at wholesale prices.

We do not publish a catalog, quotations on all short wave equipment furnished by return mail.



45-G Vesey St., New York City
New York Headquarters for Short Wave and Experimental Apparatus

Short-Wave Converters

(Continued from page 32)

preference to a small inductance and large capacity. This favorable condition is brought about by using space wound coils with solid enameled covered copper wire with a two-gang tuning condenser rated at 140 mmf.

In order to further increase the voltage on the grid of the detector tube, the input antenna "loading" is kept unusually low.

Four coils are used to cover the short-wave spectrum in the following steps:

Coil A 13 to 30 meters (23,000 to 9,994 kc.)

Coil B 28 to 60 meters (10,710 to 4,997 kc.)

Coil C 57 to 130 meters (5,260 to 2,300 kc.)

Coil D 120 to 299 meters (2,499 to 1,030 kc.)

It will be noted that each coil has an approximate frequency ratio of 2:3. This provides for broad separation of the congested bands and simplifies the process of tuning as well as the problem of accurate oscillator tracking over the entire tuning range.

The circuit of this converter is shown in Fig. 2. It uses a separate oscillator and tetrode detector, as well as a high gain i.f. stage.

Good engineering principles were adhered to when it was decided to use two separate tubes for the first detector and high frequency oscillator, principally because separating the two jobs provides for a greater oscillator stability. In most pentagrid converter circuits employing one multi-purpose tube for frequency inversion and detector the oscillator efficiency of the tube rapidly diminishes as the frequency increases. The employment of a separate triode oscillator and a separate tetrode mixer (1st detector), provides for an unusually efficient form of frequency inversion.

The antenna feeds into the primary of the first detector coil L1, the secondary of which is coupled into the tetrode mixer V1. A bias resistor of 3,000 ohms is used in the cathode to provide suitable bias. The biasing resistor is shunted by a .001 mf. condenser C1. The screen is given a lower positive potential than the plate, the voltage being reduced by a 350,000 ohm resistor R5.

The oscillator cathode (tube V2) is grounded through a 250-ohm resistor R2 across which is developed the oscillator voltage (heterodyning frequency). The high-frequency voltage is impressed upon the cathode of the mixer through C1. It will be noted that the oscillator is of the tuned grid type with a 10,000-ohm grid resistor connected between grid and ground, while a .0001 mf. blocking condenser, C3, completes the high frequency oscillatory circuit. Note the series padding con-

denser (C2) which is contained within the coil catacomb.

The output of the first detector is coupled into a doubly tuned 545 kc. i.f. transformer which, in turn, is coupled into a 78 i.f. amplifier. The resistor R4 provides a suitable bias for maximum gain, while bypass condenser C5 completes the i.f. circuit.

For short-wave coverage, a high intermediate frequency is always preferable in order to avoid interlocking between the carrier frequency and the oscillator frequency. The Deluxe Converter employs 545 kc. because of the following reasons: first, it is the lowest frequency bordering the broadcast band (there is no danger of any broadcast or police call signal forcing its way into the i.f. amplifier and causing interference; second, more stable amplification is possible at this frequency than at any other broadcast frequency; third, a greater inter-channel selectivity (5.45 kc.) is available at this frequency as compared with 15 kc. selectivity at the opposite end of the broadcast band (1500 kc.).

The output of the i.f. amplifier (V3) is impedance capacitatively coupled to the input circuit of the broadcast receiver through choke CH1 and condenser C4.

A single pole double throw switch SW1 provides for optional connection of the antenna either to the converter or to the broadcast receiver.

The a.c. model as diagrammed employs its own rectifier and hum-free filter systems. This feature obviates the necessity for using adapters or otherwise tampering with the wiring of the receiver. The power transformer, T1, furnishes 6.3 volts, from two separate windings, for the 37 rectifier as well as for the oscillator and detector. The plate and grid of the triode are tied together in a half-wave rectification system. A 30-henry filter choke (CH2) is bypassed by 8 and 16 mf. electrolytic condensers C7 and C8, which completely eliminate all traces of residual hum.

Another valuable feature of great importance is the provision for use of any type of antenna. The Deluxe Converter isolates the antenna primary from the chassis by bringing both end leads out to two insulated binding posts BP1 and BP2. A third post BP3 is connected to the chassis.

When transmission lines are used they are connected to BP1 and BP2. A single wire antenna is connected to BP1 while BP2 is grounded to BP3. If a special noise reducing antenna with coupling transformers is employed, the output of the transformer may be treated as a transmission line or a single wire aerial depending upon the best results obtained from comparative tests.

Short-Wave Station Information

(Continued from page 19)

11,830 kc. from 3:00 to 5:00 P. M.; and on 6,120 kc. from 6:00 to 11:00 P. M., Eastern Daylight Saving Time. English, French, German, Spanish and Italian are used for announcements at various times. The transmitter is located at Wayne, N. J., and is owned by the Atlantic Broadcasting Corporation, 485 Madison Avenue, New York, N. Y.

W8XK, Saxonburg, Pa.

W8XK, located at Saxonburg, Pa., operates on four frequencies on a sliding schedule as follows:

49 meters—6140 kc.—daily 4:30 P.M. to sign off
25 meters—11870 kc.—4:30 P.M. to 10:00 P.M.
19 meters—15210 kc.—daily 10:00 A.M. to 4:15 P.M.
14 meters—21540 kc.—daily 7:00 A.M. to 2:00 P.M.
(Times listed are eastern standard time)

The licensed power is 40 kilowatts. The station relays the regular programs of KDKA. It is owned and operated by the Westinghouse Electric & Mfg. Co., East Pittsburgh, Pa. Verification cards are issued to listeners.

NBC Stations

The National Broadcasting Company operates two short-wave relay broadcast stations: W9XF at Downer's Grove (Chicago), Illinois, and W3XAL at Bound Brook, New Jersey.

Reception reports are verified by the company and the station announcements are made in the English language.

The schedule in effect at the present time is as follows:

Tuesday	4:30 P.M.-8:00 P.M.-9:30 P.M.-2:00 A.M. EST
Thursday	4:30 P.M.-8:00 P.M.-9:30 P.M.-2:00 A.M. EST
Friday	4:30 P.M.-8:00 P.M.-9:30 P.M.-2:00 A.M. EST
Sunday	4:30 P.M.-7:00 P.M.-9:00 P.M.-2:00 A.M. EST

Monday	5:00 P.M.-1:00 A.M. E.S.T.
Wednesday	5:00 P.M.-1:00 A.M. E.S.T.
Saturday	5:00 P.M.-1:00 A.M. E.S.T.

Daily including Sunday—8:00 A.M.—2:00 P.M. E.S.T.

EAQ's Schedule

Much confusion seems to exist over EAQ's schedule. The following letter dated May 11, 1934, gives the real "dope":

"For your guidance we beg to inform you that station EAQ (our call letters) broadcasts daily, including Sunday, from 2230 to 2400 G.M.T. (5.30 to to 7.00 P.M., E.S.T.) and on Saturday there is a special European program from 1700 to 1900 G.M.T. (noon to 2.00 P.M., E.S.T.). Our studios are in Madrid and the transmitting equipment in Aranjuez, near Madrid. Our transmitter is a 20 kw. Marconi beam and we are broadcast with a wavelength of 30 meters or 10 megacycles. Listeners may address their communications to: Radiodifusion

Ibero Americana (Transradio Espanola), Station EAQ, P.O. Box 951, Madrid, Spain."

The letter is signed by the director of the station, whose name we cannot determine from the handwriting.

U. S. S. R. Schedule

From Miss Inna Marr, who signs herself as "chief editor" of "Radio Centre Moscow" and who writes excellent English, we learn that broadcasts in English are still being given regularly on 25 meters, the 50-meter transmissions evidently being dropped for the summer. For the summer months the schedule of English programs is quoted as follows:

"Broadcasts take place on Sunday, Monday, Wednesday and Friday from 12-1 midnight Moscow Time (9-10 P.M. Greenwich Time or 4.00 to 5.00 P.M. Eastern Standard Time), on wavelengths of 1724 and 25 meters simultaneously. On Sundays three daytime broadcasts take place as follows: 6-7 A.M. Moscow Time (3-4 A.M. Greenwich Time or 10.00 to 11.00 P.M. E.S.T. Saturday night) on a wavelength of 25 meters, frequency 12,000 kilocycles; 2-3 P.M. Moscow Time (11-12 A.M. Greenwich Time or 5.00 to 7.00 A.M. E.S.T.), on wavelengths of 1724 and 25 meters simultaneously; 6-7 P.M. Moscow Time (3-4 P.M. Greenwich Time or 10.00 to 11.00 A.M. E.S.T.) on a wavelength of 25 meters only."

Perusal of the printed programs for the months of May and June indicates that the broadcasts consist almost entirely of talks on political, economic, industrial and sport subjects, with only a promise of "sometimes music." The station on 25 meters has the call letters RNE.

A Note on the 6F7

Some tubes, especially some of the double purpose types such as the 6F7, are used in duo-circuit arrangements in which the triode section is a regenerative detector. It may be found sometimes that these tubes oscillate more strongly as the plate voltage on the triode is reduced—until a very low value is reached.

This apparent anomaly is due to a number of causes, not the least important of which is coupling between one part of the tube and the other. When wiring such tubes, therefore, be sure that the wiring around the sockets has plenty of room in order to reduce the external coupling as much as possible.

Clean cut wiring and well soldered joints are an aid to reduced coupling. A joint with rosin spread all over is equivalent to resistance coupling between tube prongs.

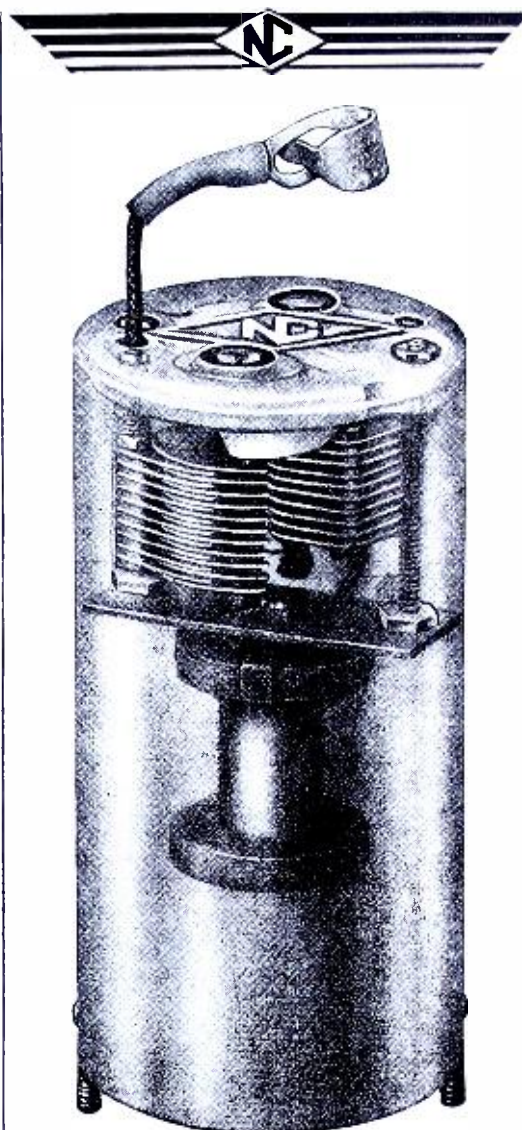

FOR STABILITY AND SHARPER TUNING

Wherever you may be located—and especially where there are wide humidity changes or in the tropics—the Standard NATIONAL Air Dielectric Condenser Tuned Intermediate Frequency Transformer will give you greater stability and sharper I.F. Tuning. Special features include: All peaking adjustments accessible at all times at top of shield, self-locking rotors, Isolantite insulation, new type of Litz-wound coils 450 to 550 K.C. tuning range (also 175 K.C. Model), Non-Resonant Aluminum Rotor and Stator Plates, standard mounting. **List Price** (subject to discount of 40% when purchased through an authorized distributor), each... **\$5.00**

Send coupon below for new Catalogue No. 220.

NATIONAL

Air Dielectric Condenser Tuned I.F. TRANSFORMER

NATIONAL COMPANY, Inc.,
MALDEN, MASSACHUSETTS.

Gentlemen:

Please send me your new catalogue No. 220. I enclose 6c to cover mailing costs.

Name.....

Address.....

SWR-8-34

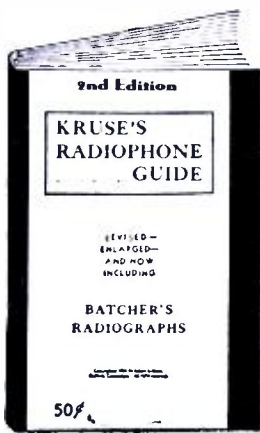

Twice as Big as Before!
is
the new
2nd
edition
of

KRUSE'S RADIOPHONE GUIDE

and just as full of operating and constructional information which isn't printed elsewhere.

And furthermore—

There's a complete set of

Batchers "Radiographs"

the simplest problem-solvers we ever saw

IN STOCK AT—

Thompson Holmes, San Francisco
Walter Ashe Radio Co., St. Louis
G. M. & C. Radio Sup. Co., Oakland
Zack Radio Sup. Co., San Francisco
Radio Specialties Co., Detroit
Warner Bros., San Francisco
E. C. Wenger Co., Oakland
Leeds, New York
Offenbach Elect. Co., San Francisco
I. S. Cohen's Sons, San Francisco
Neisner Bros., Inc., Boston
J. C. Hobrecht Co., Sacramento
Portland Radio Sup. Co., Portland
Griffith Sales Co., Tacoma, Wash.
Wedel Co., Inc., Portland
Wedel Co., Inc., Seattle
Seattle Radio Sup. Inc., Seattle
Lou Bonn Co., St. Paul
Chicago Radio Apparatus Co., Chicago
Spokane Radio Co., Inc., Spokane
Midwest Radio Mart, Chicago
Gross Radio, Inc., New York
Intercity Radio Stores, Long Beach
American Sales Co., New York
Burstein-Applebee Co., Kansas City
Abbott's Sweet Shop, Berwyn, Ill.
T. P. Cushing, Springfield, Mass.
Ports Mfg. Co., Fresno
Radio Inspection Service, Hartford
Radio Supply Co., Los Angeles
Hafry & Young, Hartford
Kronson Service Co., Buffalo
Pierson's Radio Laboratory, Sacramento
Blair the Radio Man, New York
Wilmington (Delaware) Elec. Specialties Co.
Klading Radio Laboratories, Kent, Ohio
Maurice Schwartz & Son, Schenectady
Harry's Radio Land, Long Beach
Radio Service Laboratory, Manchester, N. H.
Thompson Battery and Radio Service,
Zanesville
Radio Laboratories, Kansas City
Radio Electric Service Co., Philadelphia
Chicago Radio Apparatus Co., Chicago
Cameradio, Pittsburgh
Natick Book Store, Los Angeles
Radio Distributing Co., South Bend, Ind.
Radio Television Sup. Co., Los Angeles, Cal.
Neisner Bros., Rochester, N. Y.
Electric Supply Co., Oakland, Cal.
Coast Electric Co., San Diego, Cal.
McGills, Melbourne, Australia
Radio Supply Co., Oakland, Cal.
Uncle Dave's Radio Shack, Albany, N. Y.
Thompson Elect. Co., Manila, P. I.
Radio Sales Service, Ltd., Vancouver, B. C.
W. H. Edwards & Co., Providence, R. I.
Sun Radio, New York, N. Y.
San Francisco Radio Exchange,
San Francisco, Cal.
S.O.S. Radio Co., Honolulu, T. H.
Radio Equipment Sales Co., Detroit, Mich.
S.O.S. Radio Sup. Co., LaCross, Wis.
Inter-State Radio & Supply Co.,
Denver, Colo.
M. & H. Sporting Goods Co.,
Philadelphia, Pa.

50 cents from your dealer (75 cents in Canada) or direct from

Robert S. Kruse
Guilford, Conn.

Low-Noise Super

(Continued from page 35)

all out. During this procedure, the resistance R10 should be left all out. In other words, there should be no resistance in this circuit as yet.

The next step is to align the intermediate amplifier. This can be accomplished quite satisfactorily by ear if no test oscillator is available. One of the adjustments should be left fixed and the others carefully adjusted for maximum response.

The resistor R10 may now be adjusted until the second detector is just on the verge of oscillation. This control can now be left in this position and will require no further attention. Some slight realignment of the intermediate transformer trimmers may be necessary if they have not been made too carefully initially, since the tuning of the detector input circuit will now be extremely sharp.

When operating this receiver, the writer has noticed that on some extremely strong stations, such as local phone amateurs, overloading of the i.f. section is noticeable in spite of the precautions taken. This overloading cannot be overcome by decreasing the volume, as the volume control works in the audio circuit. In instances where this condition occurs, it was found possible to correct same by detuning the trimmer condenser C2. If the operator is in the immediate neighborhood of several strong stations, it may be found advisable to substitute a dual volume control, the second element consisting of a 10,000 ohm variable resistance inserted in the i.f. cathode lead at the point marked "x."

WEF and WCG Do Not Verify

Stations WEF on 94.90 kilocycles and WCG on 10380 kilocycles, operated at Rocky Point, L. I., by RCA Communications, Inc., are used occasionally for special stunt broadcasts. These are essentially experimental stations and they do not verify.

* * *

Primarily to provide additional frequencies for point to point radio telephone service in Alaska, at the request of the Chief Signal Officer of the U. S. Army, the Federal Radio Commission amended Rule 419-b to read as follows:

"Primarily for short-distance communication between Government and non-Government stations provided the maximum power shall not exceed 100 watts and upon the condition that no interference will result to other services, types A-1, A-2 and A-3 emission:

2616 kc.	2994 kc.
2632 kc.	3092.5 kc.
2912 kc.	3190 kc.
2986 kc.	3263 kc.
5137.5 kc.	day only
5167.5 kc.	day only
5207.5 kc.	day only

Radio "Mailbag" O. K.

(Continued from page 9)

have become a ritual. In Seattle there is a bride who had but a short month before the expedition sailed to talk with her new husband. She is a regular correspondent. In northern Canada there is a brother of one of the expedition men who sends letters to Schenectady and then hears them read to Little America over the short-wave receivers of Canadian Airways. That establishes some kind of a record. One regular correspondent, a woman, objected vehemently to a program which described the weather in Miami as "rubbing it in." One of the scientists on the expedition first learned to know the Schenectady station during two years in South America, and now he is renewing his acquaintance from a residence on the Bay of Whales.

Perhaps the most satisfactory single feature of the mailbag to those at home is the instantaneous reception of the messages. Even in domestic mail service, letters grow a little stale before they are read by the correspondent at the other end, but with W2XAF's "air mail," the time lag is defeated. The next morning often brings an answering radiogram from the Antarctic, completing the cycle.

And that is *real* service!

"Hints and Kinks for the Amateur"

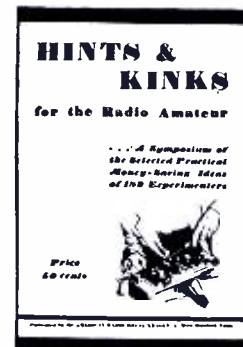

For years hams have said that one of the most practical and valuable features of all radio magazines is the experimenter's section. But—try to recall when it was you saw that swell (but, alas, only dimly remembered) suggestion for band-spreading, or a key click eliminator. What was needed was a compilation of all the best ideas, brought under one cover, segregated by subjects, and indexed. And here it is—an intensely practical book, filled out with selected additional material, with dozens of valuable and workable ideas gleaned from the practical station experience of successful amateurs. Chapters on workshop ideas, receivers, transmitters, amateur, phone QRM elimination, keying, power supply, and so on.

An ever-present help in time of trouble and worth its weight in crystals when you are desperate for an idea.
80 pages in attractive paper covers.

Price \$50
Postpaid

Standard Publications, Inc.
1123 Broadway,
New York, N. Y.

Regeneration in Tuned R. F. Stages

(Continued from page 6)

Control of volume is effected in the buffer stage by variation of the control-grid bias. This holds true, however, only when the buffer is a 58. The original Super-Wasp had no volume control, so that when a 24A is used in this position, a fixed resistor of 500 ohms should be inserted in the cathode circuit in the buffer stage and the volume control arrangement removed. This resistor should be shunted by a .01-mf. condenser. The detector circuit is a standard tickler arrangement: the tickler being the coil L3; the tuned secondary, L2; and the primary, L1. If the buffer is a 34 (or a 24A), then L1 should have about two-thirds the number of turns of L2; if it is a 58, then it may have slightly more turns.

A rather unconventional regenerative circuit is used in the tuned r.f. stage. This is shown, not because it is desirable to make the receiver complicated, but to show the different arrangements which may be employed. It must be borne in mind that the buffer stage cannot be tuned. Otherwise, the complexity of the receiver will increase. The circuit of Fig. 1 is merely a suggestion to show what can be done along these lines. Note also that the output of the detector is left open—either a resistance or a transformer coupled audio stage may be added. Figure 2 shows another type of regenerative circuit which may be employed in the tuned r.f. stage. Parallel feed is used here, and the grid of the buffer is connected to the "hot" side of the choke. In this circuit, therefore, it is the voltage developed across the tickler which is applied to the buffer grid. The

article in this issue of SHORT WAVE RADIO by Kruse, on regeneration methods, may be used to particular advantage in designing a simple receiver utilizing regeneration in the r.f. stage.

There are several points to observe in building any of the regenerative r.f. receivers. It is recommended that the buffer tube be completely shielded from the r.f. and detector stages. One method suggested in QST is to place the r.f. circuit in one shield box, the detector circuit in another shield box, and the buffer stage between the two.

In all probability, the ticklers on both regenerative stages will have about the same number of turns. In any event, the tickler in the r.f. stage should be so adjusted that this tube breaks into oscillation when the voltage applied to the screen, which is controlled by the 50,000 ohm potentiometer, is close to the normal value recommended for the tube when used as an amplifier.

In tuning this receiver, it is well to lower the screen voltage sufficiently in the r.f. stage so that this tube is well below the oscillating point. Then tune the circuit in a normal manner until a signal is picked up. Finally, the screen voltage may be increased and the r.f. tuning condenser adjusted until maximum response is obtained.

The question now arises as to whether or not a single tuning dial may be employed. The answer is "yes," providing a small trimmer is connected across C2; this condenser is labeled C3 in Fig. 1. This condenser should be a small three-plate midget of about 25 mmf. and located, of course, on the panel of the receiver.

Any number of circuits will, no doubt, suggest themselves to the wide awake experimenter. The purpose here is merely to point out how, with the addition of a tube, a socket, and a few chokes, the sensitivity of the ordinary t.r.f.-regenerative receiver may be considerably increased.

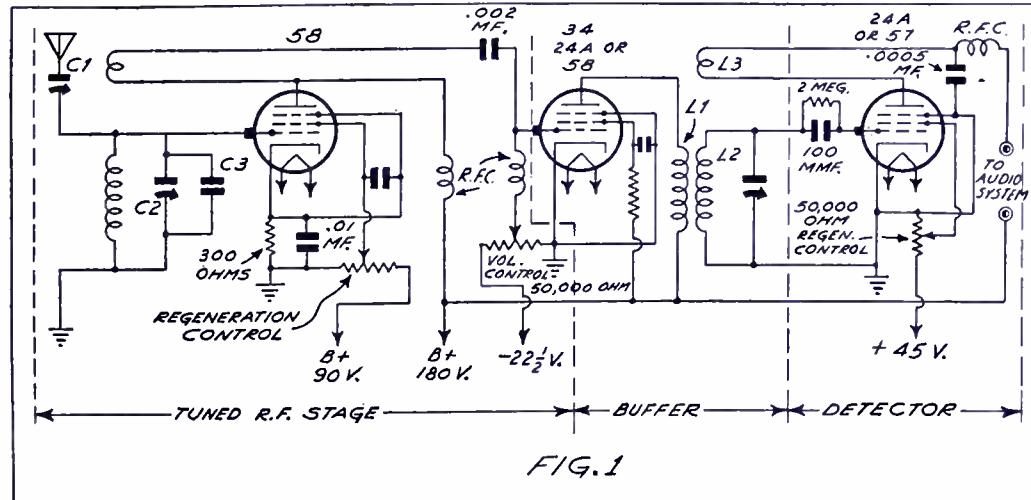
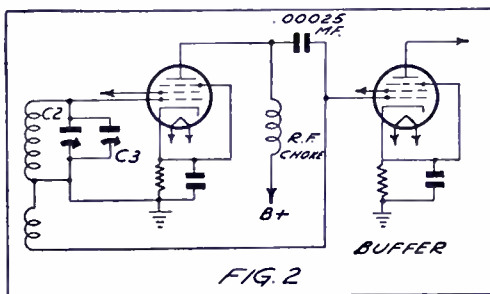

Two schematic circuits of regenerative, tuned r.f. stages. C3 is variable.



Here is a new type of Radio Catalog—one which lists thousands of items in greatest demand throughout the Summer Season! Why buy from an out of date catalog when Radio Headquarters brings you the latest, up-to-the-minute developments in this new, timely, Summer Supplement! You'll find A.C.-D.C. sets, portable phono-radio combinations, portable P.A., Marine Radios and thousands of other summer selling items.

SHORT WAVE HEADQUARTERS

In addition you'll find a big section on short wave where every leading manufacturer is represented. There are sets and kits from 2-6 tubes, all-wave receivers, condensers, coils, converters, chokes, crystals, and holders, transmitting tubes and equipment, antenna systems, etc. Everything you need for Short Wave is here... in this Big Bargain Book... at LOWEST WHOLESALER PRICES! You need this book—so get yours at once!

Wholesale Radio Service Co., Inc.
100 Sixth Ave., New York
219 CENTRAL AVE., NEWARK, N.J.

Department SWR-84

() Send me your New Summer Supplement 55D.

NAME.....

ADDRESS.....

CITY..... STATE.....

SHORT WAVE EXCHANGE

Have you some apparatus to sell or swap, or some special service to offer to other short-wave fans? Take advantage of the low rates of this department to reach other "hams". Only 5 cents per word for amateurs, 8 cents per word for manufacturers or dealers. Name, initial and address each count as one word. Not less than 10 words accepted. Cash, money order or U. S. postage stamps must accompany all advertisements. Please write clearly.

SWAP MILO BARBELLS, INDIAN MOTORCYCLE FOR A.C. SHORT WAVE SET, TYPEWRITER. Everett DePeyster, 2 Dudley Ave., Yorkville, N. Y.

THE ANSWER FACTORY has unsold many puzzles of amateur and commercial operators. Prompt quotations, reasonable prices. Robert S. Kruse, RFD No. 2, Guilford, Connecticut.

WILL BUY Scott and McMurdo Silver receivers all models. Electron Radio Co., 64-17 Broadway, Woodside, L. I., N. Y. Phone Havemeyer 9-0411.

BUILD the "Go Getter"! Complete plans for simple, inexpensive two-tube, all battery operated receiver. Easy to build at home. Instructive and interesting and brings in many foreign stations. Reliable, tested circuit with one 33 and one 34 pentode tubes. Uses four plug-in coils, covers entire short-wave range from 15-200 meters. A real receiver that gives real results. Great for boys—and their fathers, too! Plans include picture wiring diagram, schematic, battery connections, full coil winding data. Costs only ONE DIME and 3-cent stamp to cover mailing. A. A. Dolid, 5101 39th Avenue, Long Island City, N. Y.

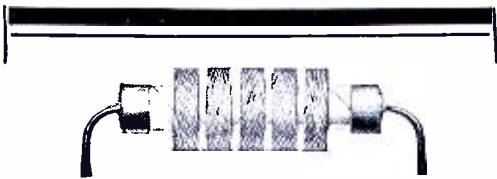

The Handy HAMMARLUND R. F. Choke

THERE are so many restricted spaces where an R.F. Choke would improve the operation of a circuit, these new Hammarlund Midgets are the answer to the radio constructor's prayer.

They are so small, compact and light, they are amply supported by their tinned copper leads. And so inexpensive they may be used generously wherever R.F. filtering is desirable.

Five universal-wound pies on Isolanite core. Inductance, 2.1 mh. DC resistance, 35 ohms. Distributed capacity, 1 mmf. Length across caps, 1½". Diameter, ½". Current, 125 milliamperes.

Whatever your radio needs may be, consult the Hammarlund Catalog first.

Write Dept., SR-8 for
Complete 1934 Catalog

HAMMARLUND MFG. CO.
424-438 West 33rd Street New York



When Seeking a Radio School

Consider RCA Institutes . . . 25 years old . . . an institution recognized as an important factor in the radio industry.

The beginner who seeks instruction in any branch of radio will find courses designed for him . . . either at the Resident Schools in New York and Chicago or the RCA Institutes Home Study courses.

Students attending our Chicago School this Summer have an added advantage in combining a study of the scientific wonders of the World's Fair.

FEATURES OF RCA INSTITUTES HOME STUDY COURSES

Extension courses for home study on convenient "no obligation" plan. Examination and technical advisory services. Free post-graduate practical training at resident school with modern equipment under instructing engineers.

Write for Catalog
RCA Institutes, Inc.
Dept. SR-34
75 Varick Street, New York
1154 Merchandise Mart, Chicago

FREE SHORT WAVE BOOK
"EIGHT METHODS FOR IMPROVING S-W RECEPTION"
Can You Answer these Questions?
1. How can you increase the signal strength of weak foreign stations?
2. How can you increase the D. X. range on your present short wave set?
3. How can you decrease the background noise?
4. What will increase the selectivity of your receiver?
5. What is image frequency?
6. How can you match your aerial to your set?
7. What is signal to noise ratio?
8. How can you get the most out of short waves?

Send for free booklet. It gives all the correct answers as well as additional valuable information for the short wave fan.

POSTAL RADIO
135-W LIBERTY ST. NEW YORK, N.Y.

Speaker Fields— How to Use Them

SUMMARY: Speaker field coils vary widely: some are small, some are large, and a few, at times, are just right for a particular purpose. We attempt, here, to outline some well-known connections of speaker field coils, so that constructors may be able to use them to the best advantage. The article is extremely practical in every sense.

MANY short-wave receivers, including the more advanced sets such as the Comet Pro, National AGS, etc., are designed to operate magnetic speakers. Comparatively few short-wave sets operate a dynamic speaker directly, unless the speaker is built right in the cabinet.

The reason for this is simple: there are so many different types of dynamic speakers available, all with different electrical characteristics, that it must be a universal set indeed that will operate all of them with the same efficiency. Moreover, quality of reception is not the important factor in most s.w. sets—sensitivity is. Magnetic speakers are cheap, easy to install, they all have about the same characteristics, and they are sensitive on weak signals.

In spite of these advantages, many people have dynamic speakers that they would like to incorporate in their short-wave sets, and others like the rich tone of the dynamic on fairly strong signals. It is our pur-

pose, therefore, to outline some of the methods whereby dynamic speakers may be connected to existing receivers.

The Dynamic

The usual dynamic speaker consists of two windings: a small one, called the voice coil, and a much larger one, called the field coil. The voice coil connects to the output transformer and takes care of the signal; the field coil must be supplied with a relatively heavy current, which depends upon the size of the speaker. It has a resistance of about 2500 ohms (although some have values ranging from 1000 to 3000 ohms) and has a big iron or steel core. The inductance of the field coil is about 20 to 30 henries, just the right size for an ordinary filter choke.

Figure 1 is a schematic of an ordinary power unit showing the connection of the choke, or field coil. The current through the winding is exactly the same current that flows through the bleeder resistor and set. Since this current is fairly constant, the field coils of speakers have been designed so as to be used in this position.

Many power packs already have a choke, and owners are not willing to take the trouble to tear them apart, but at the same time they want the advantages of dynamic speakers. For these people, the circuit of Fig. 2 is suggested. This circuit utilizes the field coil as a choke in an impedance output circuit, the only limitation to this use being that the plate current of the last tube must be large enough to supply the

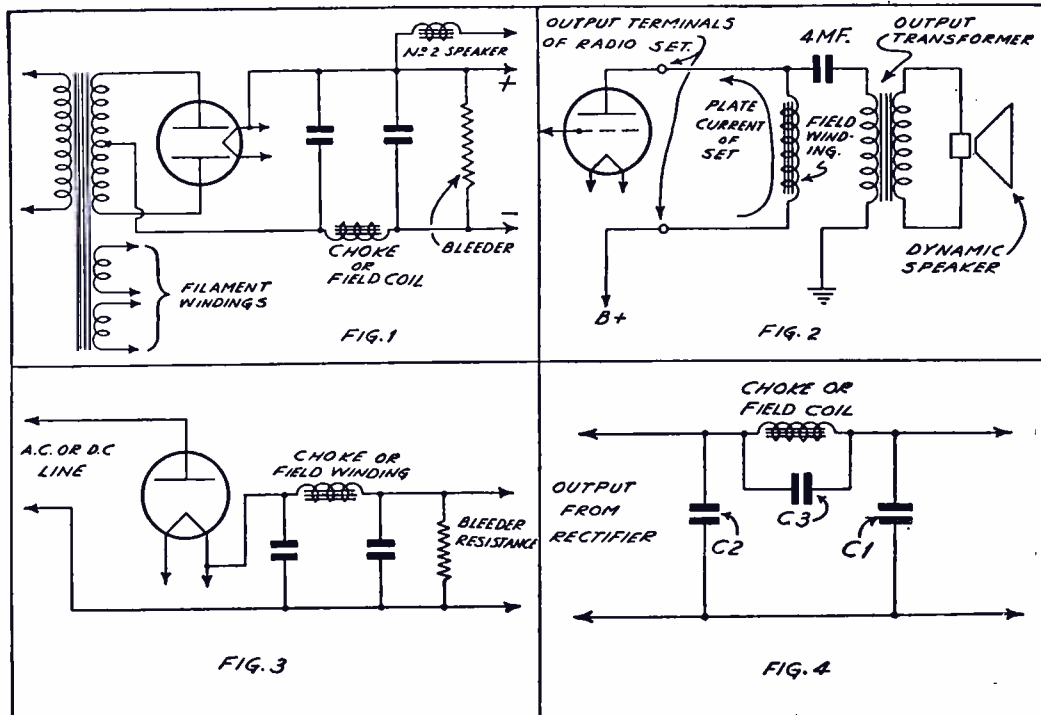

Some simple connections of speaker field coils. These are only suggestions.

field with sufficient current; also, the last tube must be a class A amplifier—most s.w. sets use class A, anyhow.

If the speaker field is of the high impedance type, it may even be inserted in the common B plus lead to the receiver; a bypass condenser may or may not be required, depending on the type of receiver. However, this point can be cleared up in a moment by the simple process of trying a bypass and noting whether or not its connection makes any difference. The field for this condition is shown as No. 2 speaker in Fig. 1. Again, the current through the field must be that required for normal operation.

A.c.-d.c. sets are difficult to handle in this respect. A conventional power unit for such sets is shown in Fig. 3. Its connection is similar to that shown in Fig. 1, although the power unit hookup is slightly different. The same limitations apply here as previously described. It is not possible to shunt the field coil across the low-voltage line, as might be thought, for the simple reason that the drain would be too great for the rectifier tube.

Bypassing the Field

In many cases, the field coil has too low an inductance for actual filtering, although it is perfectly good for reproducing voice or music, especially when there is only one place in the circuit where it may be connected. Here, the tuned filter may be used.

See Fig 4. The condensers C1 and C2 are the usual 8 mf. electrolytics. Condenser C3, connected across the field coil, should have a value of about .1 mf., depending upon the type of rectifier and the inductance of the choke. In determining the correct value, start with a .1 mf. condenser (200 volt rating is about right) and increase and decrease until the hum in the output is a minimum. This is done with the condenser C1 omitted. Then, after the proper value of C3 has been determined, a small condenser may be added at C1, say, 2 mf. This is one of the most economical types of filter circuits when once adjusted.

Field Too Small

Another case arises very often: the field coil of a speaker may be so small as to be unable to handle the relatively heavy current through it without causing damage to the iron in the core. The proper thing to do, then, is to bypass the field winding with a resistor, so calculated as to let only the proper current flow through the field.

Here is the way to calculate it. Connect up the field coil with an ammeter (d.c.) in series with it. Turn on the receiver and read the ammeter (a .5 amp. meter is about correct for the majority of sets). Now, with a voltmeter, measure the d.c. voltage across the field coil. Suppose the ammeter reads 125 ma.

and the voltmeter reads 150 volts. Let us further suppose that the speaker field is rated at .085 ampere (85 ma.). What size resistor must be connected across the speaker field to limit the current through the speaker field to 85 ma.?

A close approximation, which is suitable for all ordinary purposes, is to subtract the desired current from the actual current and divide the result into the voltage measured. In our case, the answer is $150 / .04$, or 3750 ohms. The resistor should be able to dissipate about 10 watts easily.

It should be remembered that the use of a resistor across the choke will reduce, to some extent, the choking action. Little can be done about this. An additional filter condenser will usually take care of the reduction in filtering action.

Arctic Broadcasts

(Continued from page 17)

regular radio station. Further program details will be announced later.

Flagler is now en route to the Arctic Circle and is taking equipment for the temporary station, including one of the most recent Collins radiophone transmitters, a duplicate of the one at KFZ, Little America. Supplementary equipment has been provided by KOL, Columbia station at Seattle. The exact location of the station in northwestern Alaska will not be determined until Flagler has completed tests from various points within the Arctic Circle.

Cutting Large Holes

Most set constructors find themselves in a quandary when confronted with the problem of cutting large holes for mounting tube and coil sockets of the wafer type.

The usual method is a quite laborious procedure, which requires the drilling of a series of small holes about the circumference of a circle, chiseling out the rough center disc, and then smoothing off the opening.

By utilizing a small inexpensive plumber's tool, known as a burring reamer, in conjunction with a hand drill, holes may be reamed up to $1\frac{1}{4}$ inches. Since the standard wafer socket requires a hole of approximately $1\frac{1}{8}$ inches, this tool will do the job quickly and easily. The panel is first securely clamped in a vise with a wooden board backing to prevent it from buckling under the pressure of the drill.

A $\frac{1}{4}$ inch hole is drilled through the panel and then the burring reamer is used to ream the hole to the required size.

The entire operation can be done in about three minutes and the result will be a perfectly round and well finished opening. The only precaution to observe is to remove the reamer from the drill after every ten or twelve revolutions and clear the fluted cutters of chips.

ALL ELECTRIC ALL-WAVE AIR SCOUT

Only set of its kind in the world

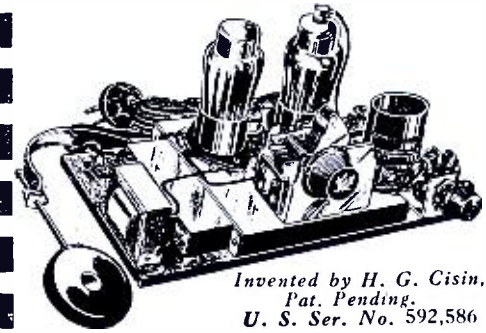

Invented by H. G. Cisin,
Pat. Pending.
U. S. Ser. No. 592,586

This powerful little set operates directly from any house lighting circuit, either a.c. or d.c. It brings in all standard broadcast stations and also police calls, foreign stations, code and trans-Atlantic phone conversations. Uses five plug-in coils to cover band from 10 to 550 meters. Compact and light—makes an ideal portable. Will operate several headsets simultaneously and will work on a short indoor aerial.

Complete set, with two tubes, earphone, two coils covering band from 70 to 550 meters, ready to plug in and use..... **\$8.50**

Same as above, less earphone..... **\$8.00**

Three extra plug-in coils to cover band from 10 to 70 meters—50c each.

BATTERY-OPERATED ALL WAVE AIR SCOUT SET complete with tube, earphone, two coils, data, instructions, assembled, wired and ready to use—**NOTHING ELSE TO BUY**—(except inexpensive batteries)..... **\$5.95**

Battery-operated Air Scout—same as above but in **KIT Form**..... **\$5.00**

AIR SCOUT 2 TUBE AMPLIFIER (for battery operated AIR SCOUT ONLY). Has built-in magnetic speaker—two tubes. Simple directions for attaching are furnished. Completely assembled, wired and ready to use (less tubes and batteries)..... **\$5.95**

Tubes for Amplifier..... **\$1.50**

NOTE: All Electric Air Scout not available in Kit Form.

SPECIAL OFFER: Valuable data on All-Wave Receivers sent upon receipt of 10c to cover handling costs. Free circulars also available.

ALLIED ENGINEERING INSTITUTE

Est. 1921

98 Park Place, Dept. CF, New York, N. Y.
Phone BArlay 7-9540

HERE LIES
STATIC
KILLED IN ACTION BY A
LANCHE
ANTENNA SYSTEM

THIS STONE IS DEDICATED TO THE MEMORY OF THE DAY ON WHICH THIS BATTLE AGAINST THE GREATEST ENEMY TO ENJOYABLE, NOISE-FREE RADIO RECEPTION WAS WON. THE COMBAT LASTED FOR YEARS. ITS WINNING HAS FREED ALL RADIO LISTENERS FROM DISTURBING HISSES, CLICKS, CRASHES AND OTHER NOISES.

ERECTED BY
ARTHUR H. LYNCH INC., 227 FULTON ST.
NEW YORK, N.Y.
WRITE TO DAY FOR FULL DETAILS

SUMMER PERFORMANCE



New S. W. Sets suitable for Summer Camps, Vacations and short trips.

PRIZEWINNER

A. C., -D. C., S. W. (15 to 200 Meters)

Completely self powered, latest type 77-43 and 25Z5 Tubes. Provision for Head Phones and Speaker. Complete, less tubes, in rich crackle-finish cabinet. Assembled, wired, tested, ready to plug in, including four coils. . . . \$12.95
Kit of RCA or Arcturus Tubes to match. . . . 3.75
Complete Kit of parts, including 4 coils. . . . 10.55

THE BYRD 2-TUBE KIT



NOTHING EXTRA TO BUY: 34 Detector, 33 Pentode Output, Micro-Vernier dial, black crackled finish hinged top cabinet. Set 4 coils, 15-200 m. Complete specifications, blueprints, hardware, wire.

\$5.75

Set of Arcturus tubes \$1.95

The Byrd is also available for 6-v tubes

YANKEE CLIPPER

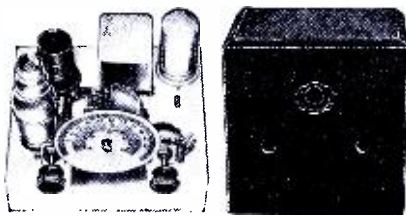

One Tube 110 V. AC-DC short wave, using 12-A-7 multi-purpose tube. Quiet built in Power Supply. Portable, for use wherever electric power is available. Price for complete kit of parts including black crystal finish metal cabinet. Hardware, instructions, etc.

\$6.75

12-A-7 Guaranteed! Tube. 1.25
Wired, Complete. extra 1.60

FREE BOOK giving complete list of short wave stations sent on request.

ALAN RADIO CORPORATION
83 Cortlandt St. Dept. 6 RN N. Y. City



FREE BOOK

HOW TO RECEIVE SHORT-WAVES ON YOUR BROADCAST RECEIVER with a POSTAL DELUX CONVERTER

If you, like thousands of other short wave enthusiasts possess a good broadcast receiver—and if you have longingly looked forward to the fascination of short wave reception—but hesitated to give up your costly broadcast receiver to purchase an expensive short wave receiver—then you should write for our free pamphlet, for it tells you how to equal, if not better the performance of most expensive short wave receivers with your present broadcast set—without any wiring changes whatsoever

GET YOUR FREE COPY TODAY.

POSTAL RADIO
135-H LIBERTY ST. NEW YORK, N.Y.

5 NEW SHORT WAVE RECEIVERS in KIT FORM

RCA brings you the first and only complete line of Short Wave Receivers in all of Radio! Now your every requirement may be filled, for the Universal Mascot Line consists of a 1-tube battery operated set for beginners; a 2-tube battery set which performs like a "3"; a 3-tube A.C. operated set giving loud speaker reception; a 4-tube A.C. set of extreme simplicity and amazing power; a 5-tube set for the "died in the wool" S. W. Enthusiast. All sets come in kit form; are licensed under RCA and Hazeltine patents and incorporate every latest improvement in circuits and tubes. Get our new, FREE descriptive literature which gives complete details, prices and discounts of the entire line. Address Dept. S-84.

INSULINE CORP. OF AMERICA
23-25 PARK PLACE NEW YORK, N.Y.

FREE! NEW RADIO CATALOG

Packed with new-model radio VALUES at rock-bottom wholesale prices! Money-back guarantee and 30-DAY FREE TRIAL IN YOUR HOME on every set. All types. Send for big new, \$9.45 free catalog TODAY. Prices. \$9.45 UP

FORDSON RADIO Inc.

Dept. 8-41, Oakman Bldg., Detroit, Mich.

The Development of the British Broadcasting Corp.

AN interesting discussion of the historical background and development of the short-wave stations in the British Empire is contained in a booklet called *The Empire Broadcasting Service*. We take pleasure in quoting from this booklet some interesting notes regarding the now famous "G" stations.

Historical

On November 6th, 1931, the B.B.C. announced its intention of immediately proceeding with plans for establishing a short-wave station to be used for broadcasting to the various parts of the Empire. Hardly more than a year later, the first transmissions were radiated from this station, which was taken into service on December 19th, 1932.

Before dealing with the scheme in detail, it is well to recapitulate briefly the events which led to the establishment of this new service.

By 1927 the transmission of broadcast programs by short-wave transmitters, especially in the United States of America and Holland, had indicated the possibilities of this form of broadcasting for spanning great distances. Such transmissions were received with some regularity by amateurs in many parts of the world, including the British Dominions and Colonies, but, of course, not with a quality comparable with local station reception. The request from parts of the Empire for transmission of British programs on short-waves was, therefore, a natural consequence, and the desirability of establishing such a service was emphasized by the Colonial Conference which was held in May of that year.

On November 5th, 1927, the British Broadcasting Corporation, by arrangement with Marconi's Wireless Telegraph Company, established an experimental short-wave transmitter at Chelmsford. This transmitter, (G5SW) was capable of putting about 12 kilowatts into the aerial, and was made up largely of existing apparatus. It transmitted on one wave only, viz., 12,500 kc. (24 meters), which was chosen as a compromise to give the best chance to most of the Empire to carry out reception experiments. The wave was subsequently changed to 11,750 kc. (25.53 meters). The program material used consisted generally of excerpts taken from the Daventry 5XX program. This experimental station was operated under license from the Postmaster General, which made clear the experimental nature of the station, the transmission of news, for instance, being forbidden.

By 1929 a considerable number of reports and data had been received by the British Broadcasting Corporation, from which several im-

portant conclusions resulted. Firstly, there was no doubt that a real, as apart from an amateur, listening interest existed, and that there was a widespread hope that a service would be undertaken. Secondly, the interest was greatest in the Colonies, while the Dominions were interested mainly in the occasional transmission of special events—for instance the Armistice Day Ceremony at the Cenotaph. On the basis of these reports and a detailed examination of the data, the B.B.C. was able to submit a fairly precise scheme for an Empire Broadcasting Service to the Colonial Office in November, 1929.

This proposed scheme, together with two variants of it, were further considered by the Imperial Conference in 1930, but owing to various difficulties which at the time could not be overcome, no definite decision was taken. In the meantime the position was becoming unsatisfactory. The existing station was not entirely representative of modern technique—it could use but one wavelength whereas several were essential—and restriction on its use in any case denied the provision of a comprehensive short-wave service to the Empire. At the same time its maintenance cost a considerable amount annually, and during 1931 it appeared that the time had come when a decision had to be made as to whether this experimental station should definitely be closed down or a new and adequate station be provided to replace it.

The need for an adequate broadcasting service was not decreasing—quite otherwise, in fact. The B.B.C. decided, therefore, that in view of the urgency of the problem, it must assume the necessary financial responsibility involved in going ahead with the scheme. It was hoped that once the new station was in operation, the interest which it would undoubtedly arouse would result in some return on expenditure in the form of a contribution from the Colonial listener, possibly as a proportion of the license fee paid by such a listener to his local agent.

Technical Requirements

The technical requirements of an Empire Station are most interesting, chiefly because they are complex and difficult. The first consideration must be the wavelengths which are available for such a service. There are six short-wave bands allotted to broadcasting by International Convention. These are of different widths and are in the neighborhood of the following waves:

6,000 kc.	(50 meters)
9,500 "	(31.6 ")
11,760 "	(25.5 ")
15,150 "	(19.8 ")
17,750 "	(16.9 ")
21,428 "	(14 ")

For an adequate Empire Service it is necessary to use one wave in each of these bands, while in two of the bands it may be necessary at certain times to use two wavelengths.

The actual waves, together with their call signs, which were notified to the Berne Bureau for the Empire Service are as follows:

6,050 kc. (49.586 meters)	GSA
9,510 " (31.545 ")	GSB
9,585 " (31.297 ")	GSC
*11,750 " (25.532 ")	GSD
11,865 " (25.284 ")	GSE
15,140 " (19.815 ")	GSF
17,790 " (16.863 ")	GSG
21,470 " (13.972 ")	GSH

* This frequency was used by the old experimental transmitter G5SW.

The Transmitters were put into service initially on these waves, but practical experience of reception in various parts of the Empire may make it necessary for slight alterations to be made from time to time, consequent on reports of interference.

Having decided on the wavelengths to be used, the next question which naturally arose was, could effective use be made of directional aerials? From examination of a globe map of the world, it immediately became obvious that the extreme limits of the Empire subtend a very wide angle at this country and, therefore, the use of one single directional aerial was obviously out of the question. In any case, a directional short-wave aerial is normally designed for one particular wavelength and therefore, at least eight such aerials would be required. Subsequent examination of the map, however, showed that from the technical point of view, the Empire could be divided into five zones, the boundaries of these zones being determined by three factors: (a) time of transmission; (b) direction of transmission; (c) the distance of the point of reception from this country.

The five zones decided on are, in general terms, as follows:

Zone 1: Australia, New Zealand, Hongkong, British North Borneo, Sarawak, New Guinea, Papua, Fiji, and the Pacific Islands.

Zone 2: India, Burma, the Malay Peninsula, and Ceylon.

Zone 3: Malta, Cyprus, Palestine, Aden, the Anglo-Egyptian Sudan, British Somaliland, certain islands in the Indian Ocean, East Africa, and South Africa.

Zone 4: Gibraltar, West Africa (includes Nigeria, the Gold Coast, Sierra Leone and Gambia), St. Helena and Ascension Islands, Tristan de Cunha, the Falkland Islands and South Georgia.

Zone 5: Canada, Newfoundland and Labrador, Bermudas, British West Indies, British Guiana, British Honduras, and the Pacific Islands.

(See Note at end of article.)

It will be seen that all these zones

do not subtend the same angle at this country, and arrangements have been made, therefore, for the angle of the transmitted beam to be different in the different cases. The narrower the beam, of course, the greater the gain in using a directional aerial. It is of interest to note, in passing, that in the most advantageous condition to be met with in this system, the theoretical gain in field strength at the point of reception, by using a directional aerial, is of the order of four times compared with the field strength at the same point of reception using a non-directional aerial. This is equivalent to a sixteen-fold increase in transmitting power.

The allocation of the wavelengths to the various zones was provisionally as follows:

Zone 1—one wavelength in the 25 meter band. Provision has been made for transmission in both directions, since the area to be served lies almost at the Antipodes of the transmitting station, and it is sometimes preferable to transmit over a westerly route, whereas at other times it may be preferable to transmit over an easterly route. In addition, it was arranged that Zone 2 aerials could be used to augment the service to parts of Zone 1 and this is now being done.

Zone 2—three wavelengths and three aerials, one each in the 17, 25 and 32 meter bands.

Zone 3—two wavelengths and two aerials, viz., 25 and 32 meters.

Zone 4—three wavelengths and three aerials, viz., 25, 32 and 48 meters, but the latter of these aerials has been arranged to cover both zones 3 and 4.

Zone 5—three wavelengths and three aerials, viz., 19, 32 and 48 meters respectively.

It will be noted that certain wavelengths, viz., 25 and 32 meters, are common to more than one zone, and as in some cases the time difference between the two zones in question may not be great, it may become necessary to serve two such zones at the same time. It is not, however, possible in practice to use exactly the same wavelength for each transmitter, and thus the reason for the use of two wavelengths in the 25 and 32 meter bands becomes obvious.

Six non-directional aerials (one for each waveband) have been erected in addition to the directional ones.

In designing a system which relies for its success on the use of short waves, it is very desirable to make this system as flexible as possible, since the best wavelength for a given time of the day and a given season is not definitely fixed. If possible, therefore, the aerial systems should be simple and economical from the point of view of first cost.

Accordingly the aerials originally installed at the Empire Station were simple in construction, supported by masts 80 feet in length.

(Continued on page 47)

BUILD SHORT WAVE!

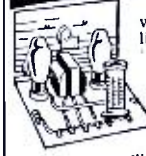

Send for our new FREE Catalog with the complete SHORT WAVE listing. Build our famous 2 tube "DX-er" described in the leading radio magazines. Complete kit of quality parts costs only \$6.73, including coils. Our 4 Tube Band-spreading A.C. Kit is a world-beater also. Anybody can build these simple, successful sets inexpensively and get thrilling SHORT WAVE results.

SOUND MEANS PROFITS

Sell SOUND Equipment during these summer months for big profits. There's a wonderful opportunity in our single unit compact Mobile Sound Systems for complete operation from a 6 volt storage battery. They're described in our new catalog along with a complete line of A.C. Amplifiers and Sound Systems ranging from 4 to 50 watts in output. If you sell SOUND, you need our book.



AMATEUR CENTER

Our new Catalog, which is yours FREE or the asking, lists the most complete line of SHORT WAVE Transmitting and Receiving equipment you could ask for... priced right and available quickly. Every AMATEUR needs this valuable new ALLIED book. Send for it today. It is packed with AMATEUR equipment representing every single famous standard line. You will find our prices consistently lower.

FREE CATALOG

Write for the valuable new ALLIED Catalog. It's FREE. In addition to complete SHORT WAVE, SOUND, and AMATEUR listings, you will find radio's most complete stock of standard replacement parts, test equipment, and a new and profitable line of World-Wide receivers. Write Dept. 1, today for your FREE copy.



Allied Radio CORPORATION
833 W. JACKSON BLVD., CHICAGO, ILL.

A Useful Directory

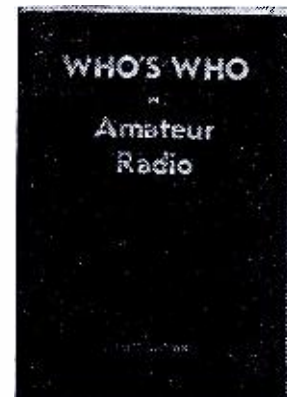

Who's Who in Amateur Radio will prove interesting to active transmitting amateurs who want to know something about the equipment and personal history of operators they contact over the air. About 3000 amateurs are listed. Photographs of some of them are included in the write-ups, which are brief but to the point.

The back of the book contains a list of the outstanding radio clubs of the United States, the United States radio inspection districts by states and countries, the International abbreviations and a condensed schedule of press, weather, and time transmissions by commercial stations.

WHO'S WHO IN AMATEUR RADIO, 6½ by 9½ inches, 160 pages, paper covers. Price, \$1.00.

Standard Publications, Inc.

**1123 Broadway
New York, N. Y.**

THREE SUMMER SPECIALS



THE INTERNATIONAL "TWO-IN-ONE"

This amazing one-tuber really performs like a two tuber—it has a 12A7, used as both rectifier and detector—AC-DC—built-in power supply that is QUIET—high ratio vernier dial—designed for earphone reception—this set has logged all principal European stations. Encased in a black, crackle finish metal cabinet, furnished with four coils (15-200 meters).

KIT	\$6.75
Guaranteed 2 in 1 Tube	\$1.25
Broadcast Coil	.70
Wired and tested	\$1.00

THE INTERNATIONAL 3

This World Wide Receiver is self-powered—A. C.—D. C.—has built-in speaker—furnishes the finest sort of DX reception.

Kit—15—200 meter coils	\$6.75
Tubes	\$2.25
Broadcast Coil 200-500 meters	.75
Wired and tested (extra)	\$1.20

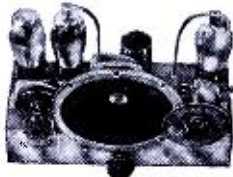

THE INTERNATIONAL S. W. CONVERTER

This two tube (6A7 and 37) self-powered Converter will give you real Short Wave reception—easily attached to any make of receiver—19 to 200 meters—has high ratio vernier dial—contained in an attractive ebony crackle finish metal cabinet.

Converter (completely assembled)	\$8.75
Matched ARCTURUS Tubes	\$1.75

EXPERIMENTAL RADIO LABS. 80E Cortlandt St., New York, N. Y.

more
than

50,000 stations

are listed in the new edition of the

RADIO AMATEUR CALL BOOK MAGAZINE

This unique "telephone book of the air" is without equal anywhere in the world. Indispensable to every short-wave amateur and experimenter. Contains ALL amateur calls, high-frequency commercial stations, press, time and weather stations, etc. 288 pages, 8 $\frac{3}{4}$ x 12 inches. Price \$1.10 postpaid.

Standard Publications, Inc.

1123 Broadway, New York, N. Y.

Log Sheets for the DX'er

These new log sheets measure full 8 $\frac{1}{2}$ by 11 inches, are printed on high grade white paper that will take ink without smudging, are ready punched to fit any standard 3-ring note book binder, and are handier than bound books. You can make rough entries on one sheet, and then typewrite them on another for permanent record. This will make up a really swell log book that you will be proud to show. Nothing like these loose-leaf sheets for convenience.

Loose-leaf log sheets, package of 50, \$.50

Postpaid anywhere in U. S. A. United States stamps, Post Office and Express Money Orders accepted. Do not send coins through the mail. These log sheets are carried in stock. Your order sent out same day it is received.

Standard Publications, Inc., 1123 Broadway, New York, N. Y.

Regeneration and Quality

OWNERS or prospective purchasers of simple, inexpensive short-wave receivers of the regenerative type must appreciate the fact that these sets achieve their astonishingly high sensitivity at the cost of tone quality. The very action of regeneration, which builds and rebuilds the strength of a signal up to the power limit of the tubes, tends to change the essential wave shape of voice and music, and in addition it produces an artificial sharpening of the tuning circuits that tends to cut off side bands and thus further distorts the reception.

All this isn't quite as bad as it sounds, as speech is still clearly distinguishable in most receivers of this kind even with the regeneration control eased up to, but not quite against, the squealing point. Music from very weak stations will sound a bit mushy, but as most DX hunters are interested in call letters and not the program, this is of little consequence.

The same distortion effects will be noticed when the receiver is "zero beated"; that is, thrown deliberately into oscillation and then tuned with razor-edge accuracy to the exact carrier frequency of the weak, desired station. Since the incoming signals and the locally generated oscillations are of the same frequency—hence the term "zero beat"—the usual whistle indicative of set oscillation will not be heard, and voice will be quite recognizable. Music, however, will be rather badly chewed up because it covers a much wider frequency range than voice and high notes will cause the fundamental carrier wave to clash with the receiver's own oscillations. Zero-beat operation of a regenerative receiver requires extremely careful manipulation of the tuning and regeneration controls, but rewards the set operator with many foreign stations not audible through ordinary tuning methods.

ZTJ and JB

A dispatch for Johannesburg, in the Union of South Africa, announces the following changes in the operation of stations ZTJ and JB:

ZTJ, which was formerly the short-wave broadcasting station of Johannesburg, now becomes its regular broadcast station, while the call letters JB have been assigned to its short-wave transmitter.

ZTJ now operates on a wavelength of 465 meters, or 645 kilocycles, and JB operates on a wavelength of 49 meters or 6,122.45 kilocycles, with five kilowatts of power.

Programs are fed to both these stations from studios located in the heart of Johannesburg, and the transmitters are located on the Witwatersand (Gold Reef) near Maraisburg.

The Development of the British Broadcasting Corp.

(Continued from page 45)

With the development of the service, it has become desirable to carry out some experiments on types of aerial different from those initially installed and three additional non-directional aerials have been erected—one each for the 16, 19 and 25 meter wavebands. These three aerials are all of the horizontal dipole type, and have been suspended from the long-wave station masts at approximately 300 feet above ground. The results obtained up to date are most promising and further additions to the aerial system will be made from time to time as experience shows to be useful.

Having considered the wavelengths and the aerial systems to be used, the next question of importance is that of the type and number of transmitters necessary to feed these aerials. If it were necessary to transmit on five different wavelengths to the five zones simultaneously, it would obviously be necessary to have five separate transmitters, but a consideration of the time difference between the various parts of the Empire has shown that it is not necessary to serve more than two zones at one and the same time. It, therefore, follows that two transmitters will suffice. If at any time the hours of transmission were considerably extended, or it became necessary to serve all the zones simultaneously, then, of course, additional transmitters would have to be added.

Having decided on the number of transmitters, one must next consider the type of transmitter, firstly its power and, secondly, its general characteristics. Experience of short-wave work over many years has shown that an aerial power of the order of 15 to 20 kw. is a reasonable figure to adopt, and the Empire transmitters have, therefore, been built for this power. As far as the high-frequency characteristics of the transmitter are concerned, it is obviously desirable that the stability of wavelength should be high, and in this respect the transmitters conform to the recommendations of the International Technical Consulting Committee for Radio Services—i.e., an error not exceeding plus or minus one part in 10,000. Actually, quartz-crystal drivers are used, giving a better performance than this (viz., one part in 25,000), and in order to permit the necessary flexibility of operation of the two transmitters on eight wavelengths some twenty separate crystals are provided.

As far as modulation characteristics of the transmitters are concerned, it might seem at first that an exacting specification for frequency characteristic would not be necessary, since conditions of short-wave reception, particularly during times of differential fading, are generally against the reproduction of

very high musical quality. However, in order to allow the best quality to be obtained when reception conditions are good, these transmitters have a very good over-all frequency characteristic, similar to that of modern medium-wave broadcasting transmitters.

As far as the depth of modulation is concerned, it is most important that a high mean degree of modulation should be employed, in order to give the best possible chances of reception, and the transmitters have been designed to be capable of a high peak modulation without distortion. Lately, some important changes in the zones were made.

Important Note

It has become increasingly obvious that the zonal basis, as an indication of geographical areas of reception, would have to be abandoned. Even in the early days of this year, 1933, reports were received on reception in the West Indies of the so-called Indian zone program, which also gave a program service in Western Australia. More recently, there has been a marked increase in the area of reception of the latter part of African and West African zones' program, which has been heard well by British communities in South America, and also in the West Indies and in New Zealand. This overlapping from zone to zone pointed to the fact that confusion would be caused by an adherence to geographical areas, even if they had broad limits.

As from October 8th, the daily transmissions from the Empire Station will be divided into five sessions, (as at present), but will be known as Transmission No. 1 (former Zone I), Transmission No. 2 (the non-directional program), Transmission No. 3 (former Zone II), Transmission No. 4 (former Zones III and IV), and Transmission No. 5 (former Zone V). It will then remain for each listener to select any program which he may be able to receive and in which he is interested. Those responsible for the arrangement of the programs and news bulletins will keep in mind that, as a general rule, the majority of listeners to a particular transmission are likely to be situated in sections of the Empire overseas on the lines of geographical zones observed in the past.

For example, the news bulletins in Transmission 1 will primarily be directed to Australasia; in Transmission 3, to India, Burma, Malaya and Ceylon; but other bulletins will be extended to cover listeners in the wider areas in which reception of certain transmissions is possible. In announcements, the calling of a zone will no longer be heard, but the usual lines of identification will be followed in regard to wavelengths.

LEARN CODE

in HALF
the Usual Time!

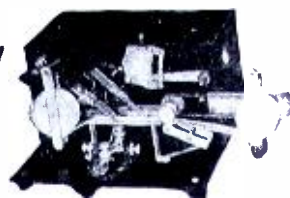

It's Easy to do
at Home with

THE NEW MASTER Teleplex

Code Teaching Machine

As a child, you understood spoken English long before you could read or write. You learned by hearing. CODE is the same way! Why make it hard for yourself, trying to learn with old-fashioned printed lessons alone? HEAR as you learn, and learn in half the time, with The New Master Teleplex. This world-famous instrument records your sending visibly, then sends back to you through headphones! The natural method, beginners learn faster, ops speed up their work amazingly. Used by U. S. Army and Navy, R. C. A., A. T. & T., and others. We give you Complete Course, lend you instrument, instruct you personally—all under MONEY BACK GUARANTEE. Low cost, easy terms. Write now for folder S. C. 20—no obligation.

TELEPLEX COMPANY

76 Cortlandt Street New York, N. Y.

"SOUND—ITS FUNDAMENTALS AND METHODS OF APPLICATION"

The use of "sound" systems of various kinds is increasing so rapidly that every radio man should familiarize himself with the different types of public address amplifiers, microphones, pick-ups and numerous other accessories now available. This excellent 60-page booklet, measuring 9 x 12 inches and printed on high grade paper, was issued originally as a piece of promotion literature by a large manufacturer, but it contains so much valuable information that we feel it is well worth its slight cost—only 25 cents, postpaid.

STANDARD PUBLICATIONS, Inc.
1123 BROADWAY NEW YORK, N. Y.

Compare!

and your choice is sure
to be

MASTERPIECE II



Compare all the engineering facts . . . and then compare the actual performance of MASTERPIECE II to other all-wave receivers, custom-built or otherwise. You'll find MASTERPIECE II the only receiver having ALL the features necessary to yield *really enjoyable* reception of European and other far off stations. Read the complete story of MASTERPIECE II in my new book . . . see why Admiral Byrd and others to whom dependable transoceanic reception is vital, chose MASTERPIECE II. See for yourself why MASTERPIECE II is so good that I can offer it on an unconditional 10 day trial, money back without question. This book is FREE. Send coupon today.

McMURDO SILVER, INC.

3360 N. Paulina Street, Chicago, U. S. A.

McMurdo Silver, Inc.
3360 N. Paulina St., Chicago, U. S. A.
Send free book giving full details of MASTERPIECE II.
Name
Street
Town State

have

SHORT WAVE RADIO

sent directly
to your home

If your local newsdealer does not carry a large stock of national magazines, you will find it much more convenient — and a little cheaper, too — to have SHORT WAVE RADIO sent directly to your home or office. A year's subscription costs only \$2.50 (\$3.00 in Canada and foreign countries), and your copies will reach you without delay. Use the handy coupon below. Post office or express money orders, bank checks and U.S. stamps accepted. Do not send coins through the mail.

Twelve issues of SHORT WAVE RADIO will bring you information and enjoyment worth many times the slight price of the magazine. Among the contributors you will find the best-known men in the short-wave field: Denton, Kruse, Worcester, Lynch, Cisin, Hinds, Brennan and Shortt.

STANDARD PUBLICATIONS, INC.
1123 Broadway, New York, N. Y.

Enclosed is \$..... Send me SHORT WAVE RADIO for one year, starting with the issue.

Name

No. and Street

City

State

Please write clearly

1818 pages of information!

“THE HANDBOOK OF CHEMISTRY and PHYSICS”

20th year of publication

FOR twenty years the Handbook of Chemistry and Physics has been giving a unique service to those in need of accurate tables, formulas and scientific data in a single convenient volume. The Eighteenth Edition represents a 20-year accumulation of necessary data for the busy scientist, engineer and experimenter, that is not only acceptable but highly essential in the commercial, educational, research and home laboratory.

Constant revision, year by year, brings you, in this 20th Anniversary Edition, 1818 pages of the most up-to-date data procurable. With the Eighteenth Edition available, you do not need to rely upon obsolete reference works, incomplete data or original papers which are often hard to locate. Of particular interest to the radio experimenter are the greatly enlarged table of characteristics of Thermionic tubes, dozens of valuable tables of mathematical functions and formulas and numerous chapters on sound, electricity and light.

This handbook is generally regarded as the most complete single reference book for the scientific worker. It is the kind of book that you will keep on your desk or work-table, not in the bookcase.

Price **\$6⁰⁰** postpaid

(Special price to students; write for details)

order from

STANDARD PUB., INC.,
1123 Broadway New York, N. Y.

INDEX TO ADVERTISERS

Alan Radio Corporation	44
Allied Engineering Institute	43
Allied Radio Corporation	45
Books	2nd & 3rd Covers, 40, 45, 46, 47, 48
Experimental Radio Laboratories	46
Fordson Radio, Incorporated	44
Hammarlund Manufacturing Company	42
Insuline Corporation of America	44
Kruse, Robert S.	40
Leeds Radio	38
Lynch, Arthur H., Incorporated	43
McMurdo Silver, Incorporated	47
National Company, Incorporated	39
National Radio Institute	1
Postal Radio	42, 44
Radio & Technical Publishing Company	3
RCA Institutes, Incorporated	42
Short-Wave Exchange	41
Teleplex Company	47
Wholesale Radio Service Company, Inc.	41



**Have you a friend who is
also interested in short waves?**

DO him a good turn; show him this copy of **SHORT WAVE RADIO**. Mind you, we said "show," not "give". If you let it out of your sight you probably won't see it again! He will want to study that masterly article on regeneration by Kruse, or build Worcester's latest set, or copy Hinds' "dope" on the foreign stations.

If your friend holds on to your copy too tightly, just point significantly to the page opposite, and even offer him your pen so that he may fill out the coupon. A subscription is only \$2.50.

SHORT WAVE RADIO

Independent—Accurate—Unbiased



NEARLY EXHAUSTED!

\$1.00

Postpaid

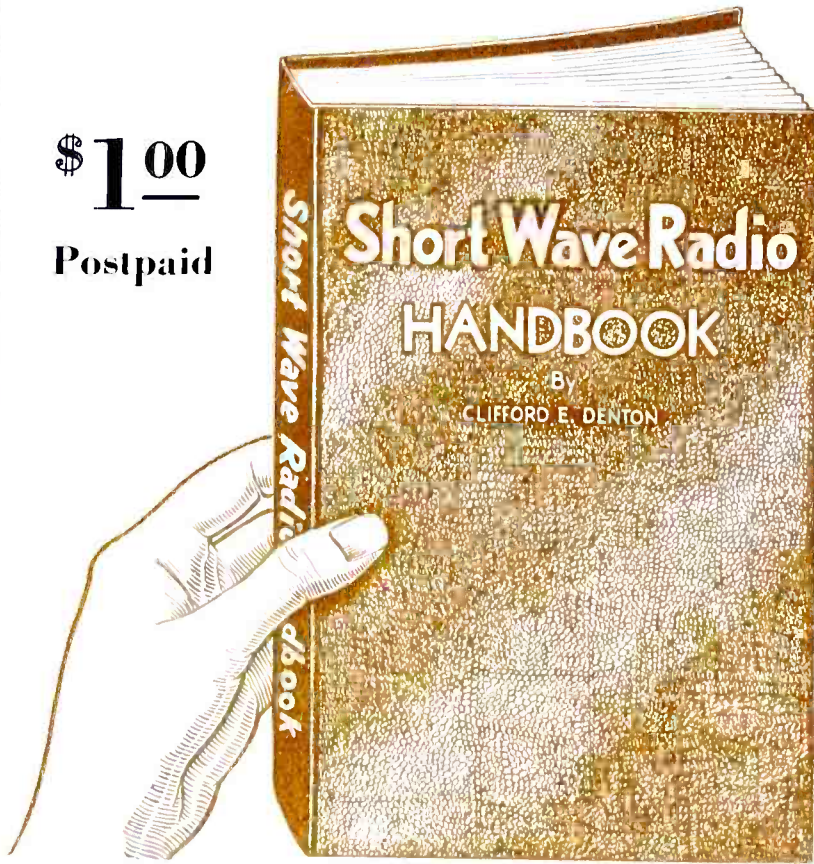

Partial Contents

Earphones, magnetic speakers, dynamic speakers, baffles and horns, loudspeaker coupling systems, turns ratio of output transformers, power sensitivity of output tubes, amplifiers, radio vs. audio amplification in s.w. receivers, audio-frequency amplifiers, audio circuit coupling considerations, detector circuits and s.w. receivers, detector tube performance curves, r.f. amplification, resistance-coupled r.f. amplifiers, transformer coupling in r.f. circuits, direct-coupled r.f. amplifiers, tuning coils and condensers, inductances at r.f., eddy currents, dielectric losses, coil capacity, fixed condensers, high-frequency bypass condensers, condensers in resistance-capacity filters, antenna circuits, reflex circuits, s.w. converters, s.w. superheterodynes, single signal reception, super-regeneration, neutralization, antennas for s.w. use, power supply units, methods of obtaining bias, power requirements, Capt. Hall's advice to s.w. listeners, ratings of condensers, resistors, etc., construction of s.w. receivers and oscillators.

The first printing of the SHORT WAVE RADIO HANDBOOK

is nearly exhausted, and there will be no further printings at the present price of ONE DOLLAR. There is a limited number of copies available at the present low price, which cannot be duplicated because of increased paper and printing costs. **BE SURE TO GET YOUR COPY NOW!**

Without doubt, the SHORT WAVE RADIO HANDBOOK is the most comprehensive compilation of practical short-wave data that has ever appeared in a single book. It is authentic, condensed, well illustrated, and contains the type of information long demanded by short-wave experimenters. Just examine the table of contents and convince yourself of this fact! Every part of the book has been carefully edited; the coil data are presented in a simple and extremely handy form; you don't have to wade through tables and charts to know exactly how many turns to put on a coil. The section on audio amplifiers suitable for s.w. sets is the most complete of its kind in print. Converters, supers, wire tables, etc., are discussed fully.

Your remittance of \$1.00 will bring the HANDBOOK directly to your home without delay. **USE THE COUPON NOW BEFORE IT IS TOO LATE!**

Standard Publications, Inc.
1123 Broadway, New York, N. Y.

Gentlemen:

Enclosed please find \$1.00 (U. S. stamps, bank check, postal or express money order accepted) for which please send me one copy of Denton's SHORT WAVE RADIO HANDBOOK. (If a dollar bill is sent, wrap it up in several layers of paper.)

Name.....

Street and number.....

City and State.....

Please print clearly

Standard Publications, Inc.
1123 Broadway
New York, N. Y.